

Sensors & Applications
Semiconductor Industry

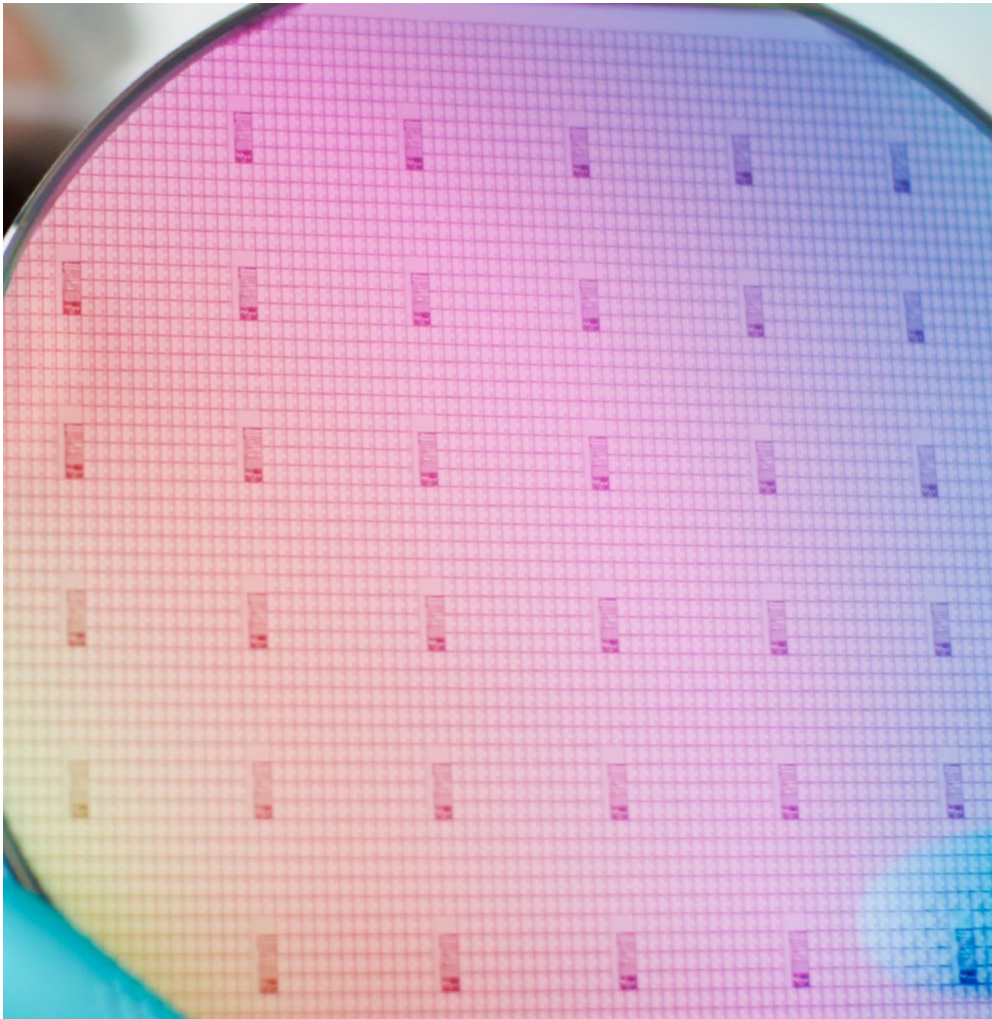

More Precision.



More precision
in the semiconductor industry

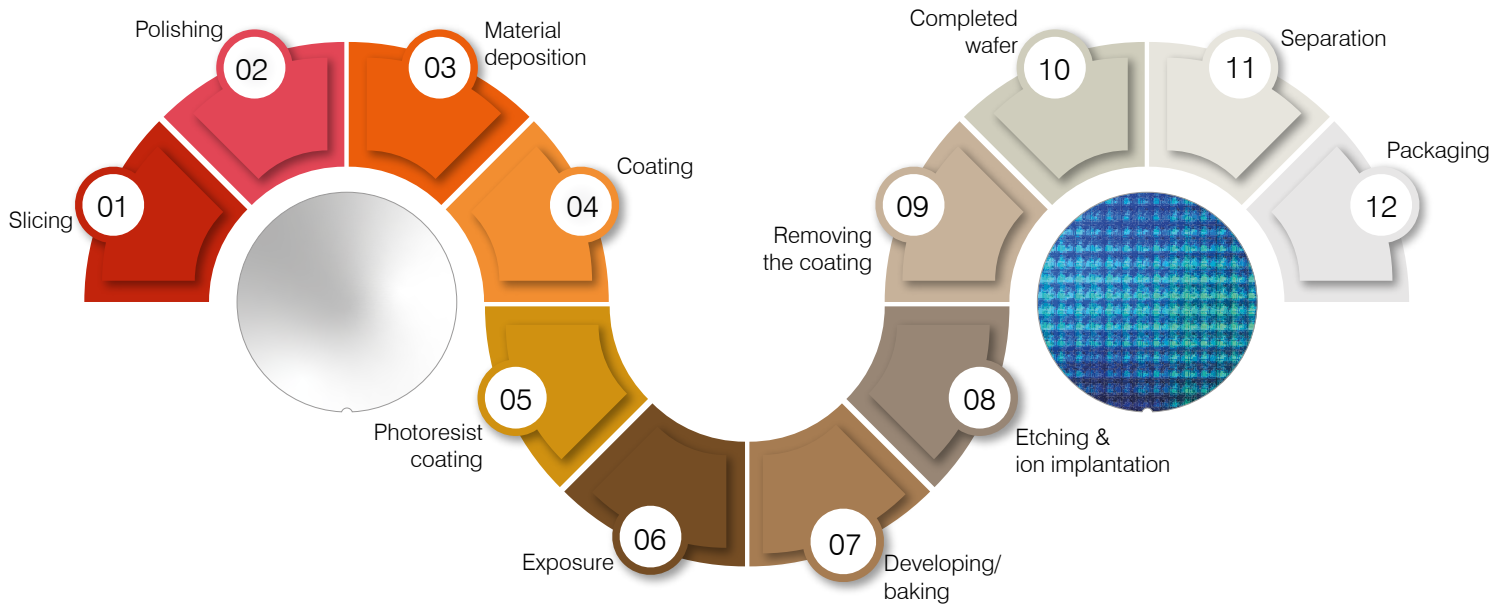

Measurement tasks in the semiconductor industry place high demands on the sensors used. Micro-Epsilon offers a wide range of high-precision displacement sensors that are used for various measurement tasks along the entire process chain in semiconductor manufacturing and processing.

Our sensors deliver exceptional performance in all process steps and are used around the world by leading machine builders and semiconductor producers – for example in environments with high acceleration, strong magnetic fields and ultra-high vacuums. Applications for the sensors include wafer fabrication, metallization, lithography and packaging.



Optical sensors

- Nanometer-precise measurement of position, orientation and thickness of wafers and coatings
- Alignment of optics, machine parts and handling



Electromagnetic displacement sensors

- Nanometer-precise distance monitoring for optics
- Fine positioning of machine parts and handling elements



Temperature and color sensors

- Non-contact sensors for measuring temperature and color



Micromechatronic systems

- High-precision sensor-actuator systems for lithography and optical systems

In-house
manufacturing with
the latest equipment
for extra fast
response times

Decades of
experience and
industry expertise

High delivery capacity
and consistent
cooperation

Sensor design
for easy cleaning

Experience with
standards and
regulations

Material variety,
e.g. titanium, Inconel,
Invar, Kovar

Vacuum-compatible
solutions incl. UHV

Compliance with
clean room conditions

Sensors and
accessories made of
low-outgassing
materials

Ready for semicon

Due to the high demands of sensor production, all sensors and systems by Micro-Epsilon are put through rigorous manufacturing and test processes. This relates to the selection and placement of the electronics, the mechanical manufacturing procedure and special process technology.

The methods used make it possible to manufacture sensors, actuators and precision mechanics with the highest standards of quality. This enables the production of high-performance, high-precision, robust and individual application solutions that prove their worth in optics, precision mechanical engineering as well as electronics and semiconductor production.

Customized developments

From the initial inquiry to the final execution of the project, Micro-Epsilon stands for "More Precision" – which includes using the most suitable measurement method in the specific application or carrying out application-specific modifications. Our goal is to work together with our customers on the ideal application solution. The standard sensor portfolio can be perfected at any time by making modifications that are adapted to the measurement task at hand.

Why Micro-Epsilon?

- More precision and innovation – Made in Germany
- Consultation, development & production from a single source
- Hand in hand with our customers: quality and problem-solving expertise in series & OEM
- In-depth technological and practical knowledge

Manufacturing technologies for customized sensor solutions

USP laser technology

Ultra-short pulse laser technology and the use of red and green lasers ensure excellent welding accuracy. Permanent hermetically sealed connections are ensured with minimal energy input.

High-temperature vacuum brazing

High-temperature vacuum brazing processes allow for hermetically sealed ceramic-to-metal connections. The ceramic circuit boards and sensor elements are manufactured in the Micro-Epsilon company group.

Precision manufacturing

In order to produce mechanical precision parts with a high level of accuracy, machining is carried out on state-of-the-art 5-axis machines.

Burn-in tests

Extensive burn-in tests ensure that the high demands on the service life of Micro-Epsilon's products are met throughout the entire product life cycle.

Fully automated potting lines

Completely bubble-free potting ensures excellent potting results and component longevity.

Passivation and coating of components and switch groups

Modern coating processes can be used to coat numerous surfaces almost entirely. This enables uniform application even in hard-to-reach places such as edges or gaps.

Quality control in wafer fabrication



- Non-contact measurements from a safe distance
- Robust sensors for harsh environments
- High accuracy and signal stability

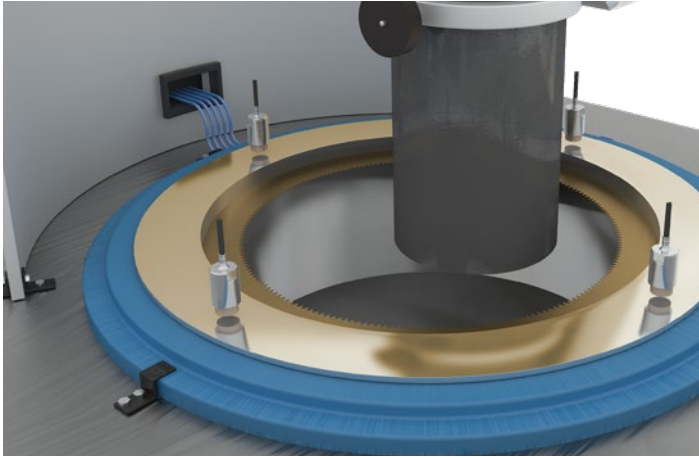

Monitoring the axial movement of annular saws

Annular saws are used for cutting silicon ingots. The saw blade or the holder is monitored using eddy current sensors. Thanks to their high frequency response and insensitivity to dust and contaminations, the sensors provide reliable measurements of the saw blade's axial deviation. This ensures a homogeneous and uniform cut for the silicon wafers.

Sensor: eddyNCDT

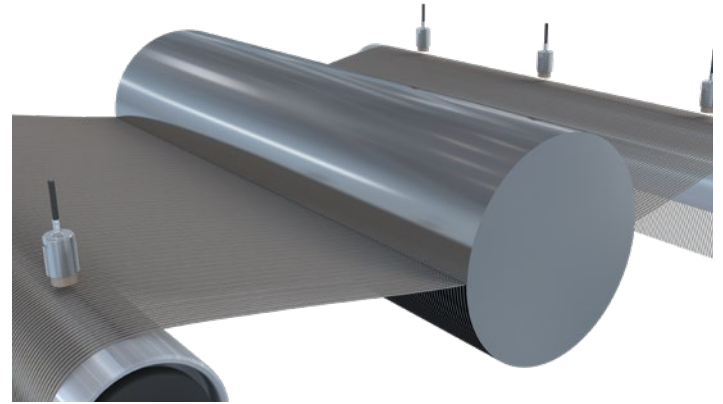

Monitoring the deflection of wire saws

Wire saws are used to cut ingots in one step. Since the wire is subject to high wear, the wire bed is monitored at several points using eddy current sensors. They detect the wire height on the guide roller as well as the wire sag, thus enabling fast and highly precise detection of wire wear.

Sensor: eddyNCDT

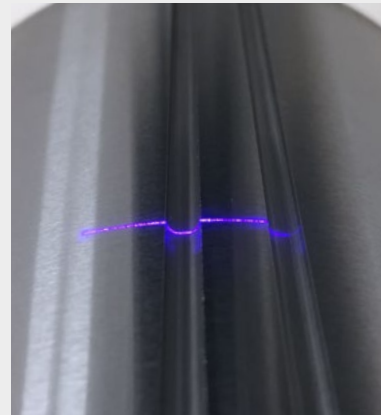
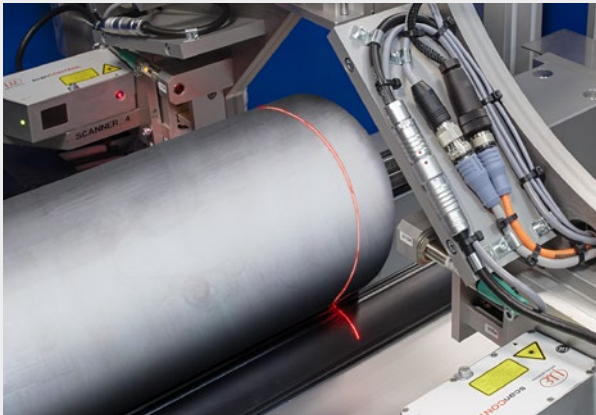

Detecting the geometric properties of ingots (left)
Checking the notch profile with blue laser scanners (right)

Dimensional inspection of silicon ingots

Laser profile scanners by Micro-Epsilon are used to inspect the geometry of silicon ingots. They detect the entire geometry of the silicon rods. This allows geometric deviations to be determined. Ingots are provided with orientation notches, which are required for aligning the ingots. Blue laser scanners by Micro-Epsilon are used to check the profile of the notches for dimensional accuracy – and do so with high precision.

Sensor: scanCONTROL

Monitoring the mask alignment

- High-resolution measurement down to the nanometer range
- Fast measuring rates for dynamic process monitoring
- Ideal for regulating and monitoring mask alignment

Positioning and alignment of lithography masks

In the lithography process, high-resolution measurements with long-term stability are required to achieve maximum precision when recording machine movements. Depending on the accuracy requirements, installation space and metrological specifications, various measurement methods from Micro-Epsilon can be used to monitor the ultra-precise mask alignment and fine positioning

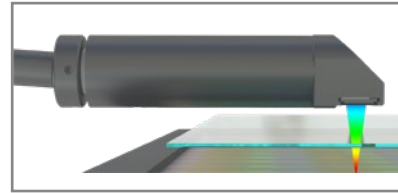

Confocal chromatic sensors monitor the gap between the mask and the glass. Thanks to the 90° design, the sensors can be integrated in an extremely space-saving manner.

Sensor: confocalDT

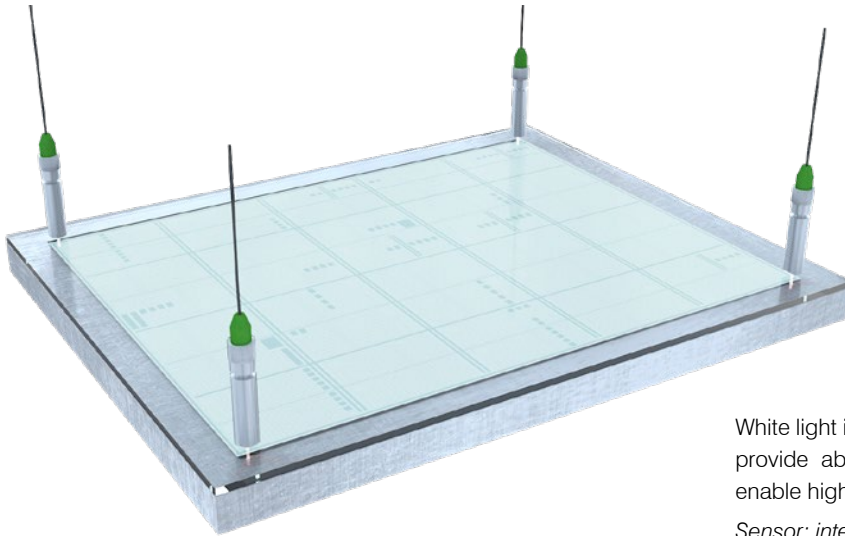
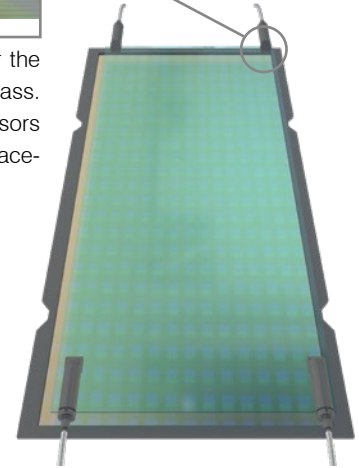

White light interferometers are used for mask alignment. The interferometers provide absolute measurement values in the subnanometer range and enable high-precision positioning of the mask.

Sensor: interferoMETER

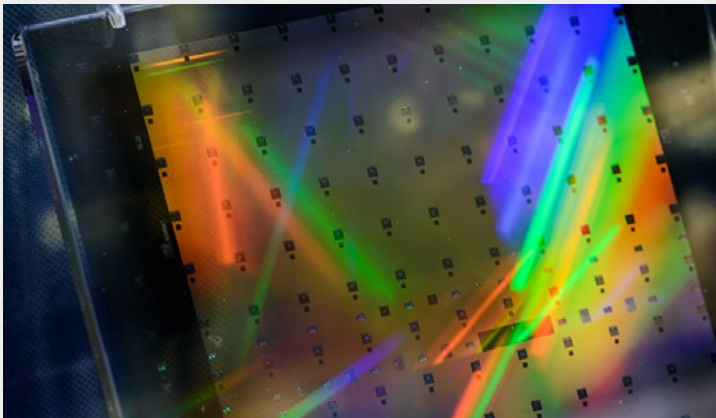

Capacitive displacement sensors provide long-term stability for the monitoring of mask alignment. The sensors provide a resolution in the nanometer range and can be easily integrated thanks to their multi-channel capability.

Sensor: capaNCDT

Monitoring the lens system

- 
- Non-contact measurements with high dynamism
 - High resolution down to the nanometer range
 - Optical and electromagnetic sensors

Position measurement of lenses and optical systems

Highly dynamic displacement sensors detect the position of lens elements and mirrors without contact so as to achieve the highest possible imaging accuracy. The sensors measure against the metallic mount and also directly onto the lens. As a result, the sensors detect the horizontal and vertical movement of individual mirrors, lenses and lens carriers.

Confocal chromatic sensors are used to measure the alignment of the optics. Several sensors measure directly onto the optics in order to detect the tilt with nanometer precision.

Sensor: *confocalDT*

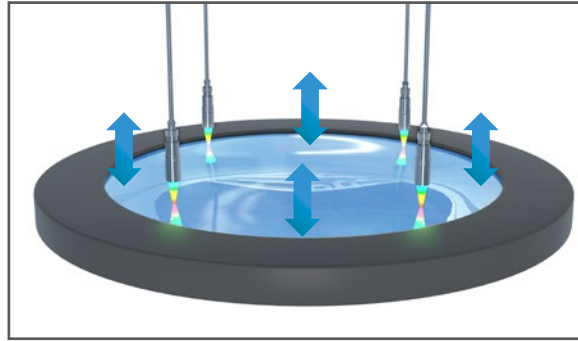

Capacitive sensors measure the tilt of lens carriers with nanometer precision, which ensures a repeatable projection.

Sensor: *capaNCDT*

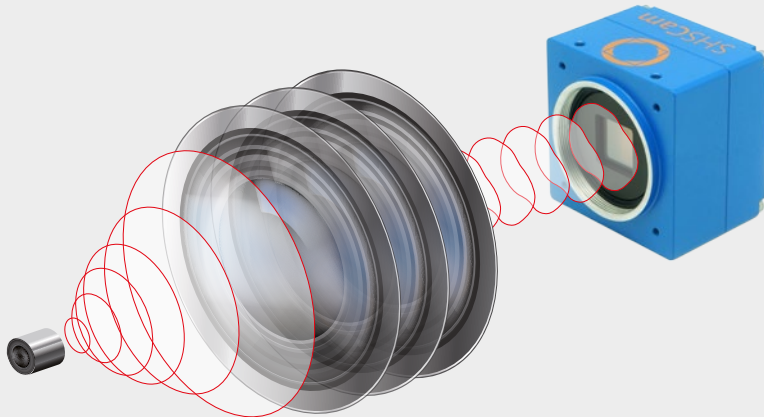
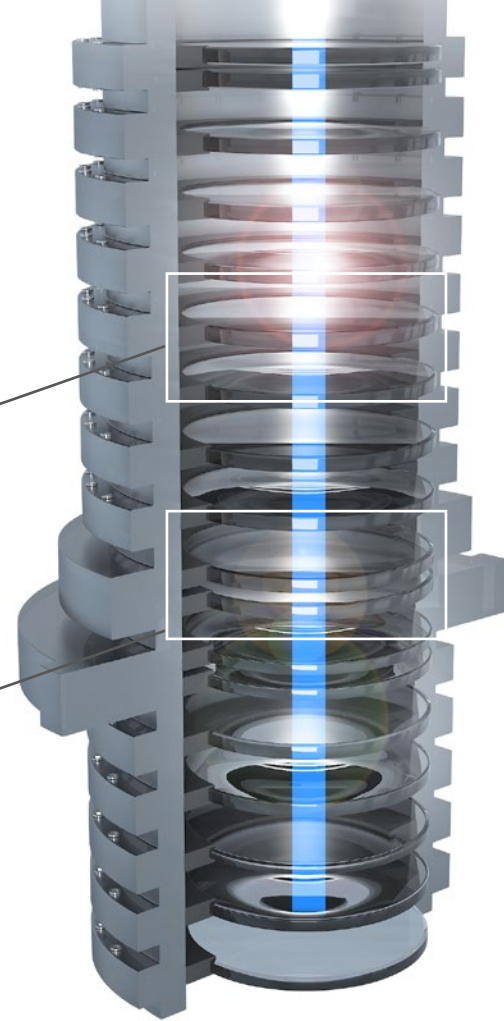
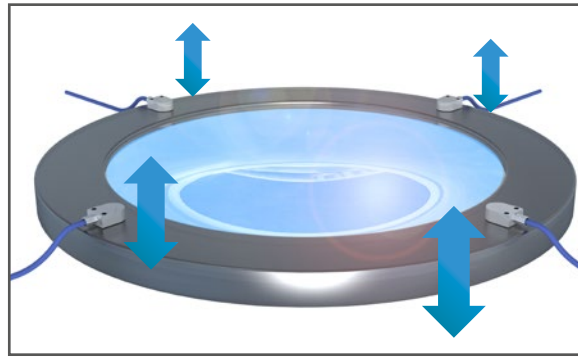

Monitoring optical systems with wavefront sensors

Shack-Hartmann wavefront sensors by Optocraft measure the alignment and imaging quality of the entire optical system. The tried-and-tested measuring principle allows for machine integration and automated measurement sequences, as well as laser beam analysis and monitoring of laser beams in the machine.

Sensor: *SHSLab*

Positioning during wafer handling

- Non-contact measurements with high precision
- High-resolution monitoring of wafer and machine movements
- Ideal for regulation and alignment

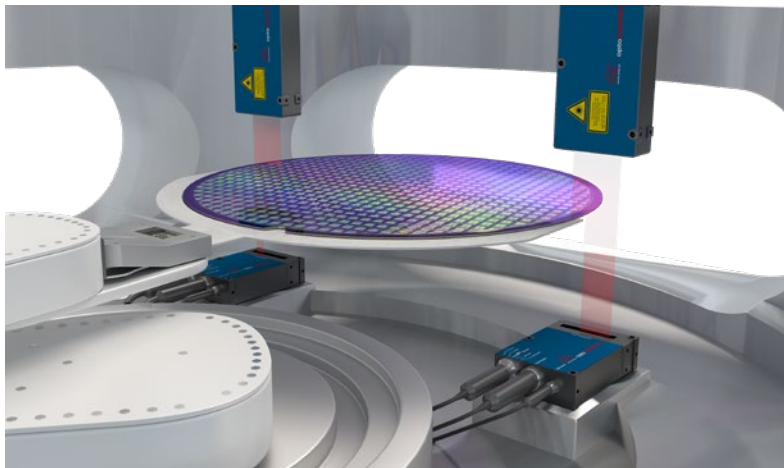

Position determination during wafer handling

When handling wafers, exact and repeatable positioning is crucial. When feeding wafers, two optoCONTROL laser micrometers check the diameter and thus determine the horizontal position. Thanks to the high measuring rate and the high measuring accuracy, the micrometers provide reliable data on the position.

Sensor: optoCONTROL 2520

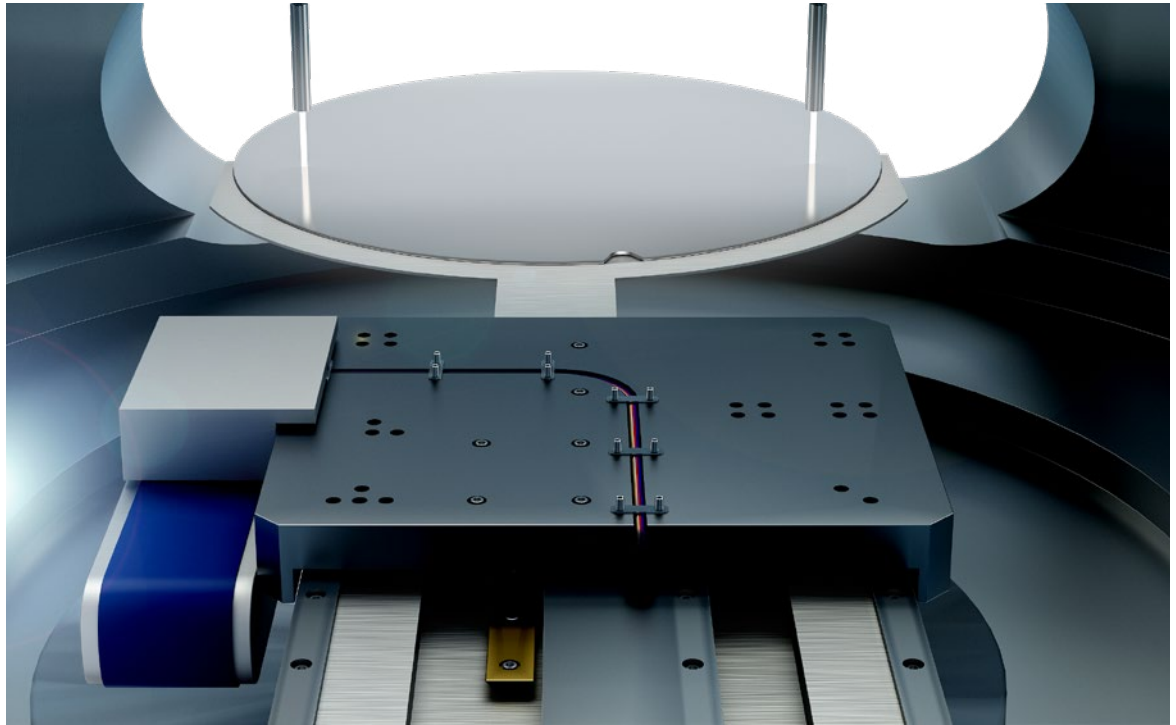

Wafer tilt measurement

White light interferometers are used to measure the horizontal tilt of wafers when wafers are being fed in. The interferometers provide absolute distance values at subnanometer resolution. The measurement ensures the greatest possible positional accuracy when wafers are picked up and removed.

Sensor: interferoMETER IMS5600

Position monitoring in the stage



- Non-contact measurements with nanometer precision
- Robust and insensitive to magnetic fields, EMC and acceleration
- Sensors designed for vacuums and UHVs

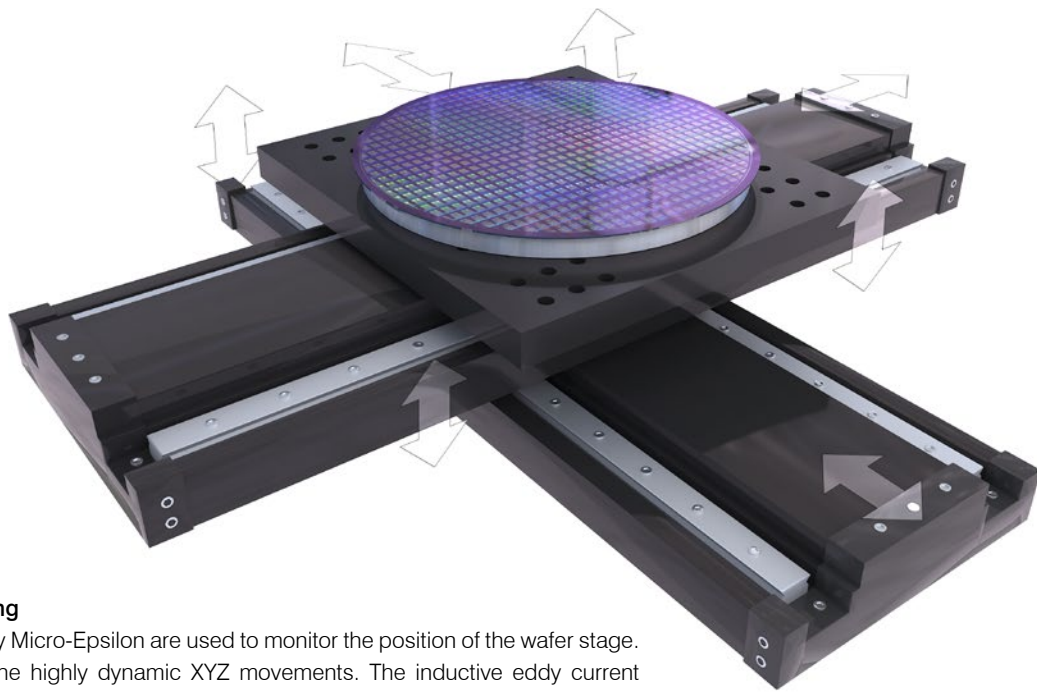

Wafer stage positioning

Non-contact sensors by Micro-Epsilon are used to monitor the position of the wafer stage. There, they measure the highly dynamic XYZ movements. The inductive eddy current sensors achieve a resolution in the nanometer range. Thanks to their robust design and high dynamism, the stage position is reliably detected even at the highest rates of acceleration.

Sensor: capaNCDT / eddyNCDT

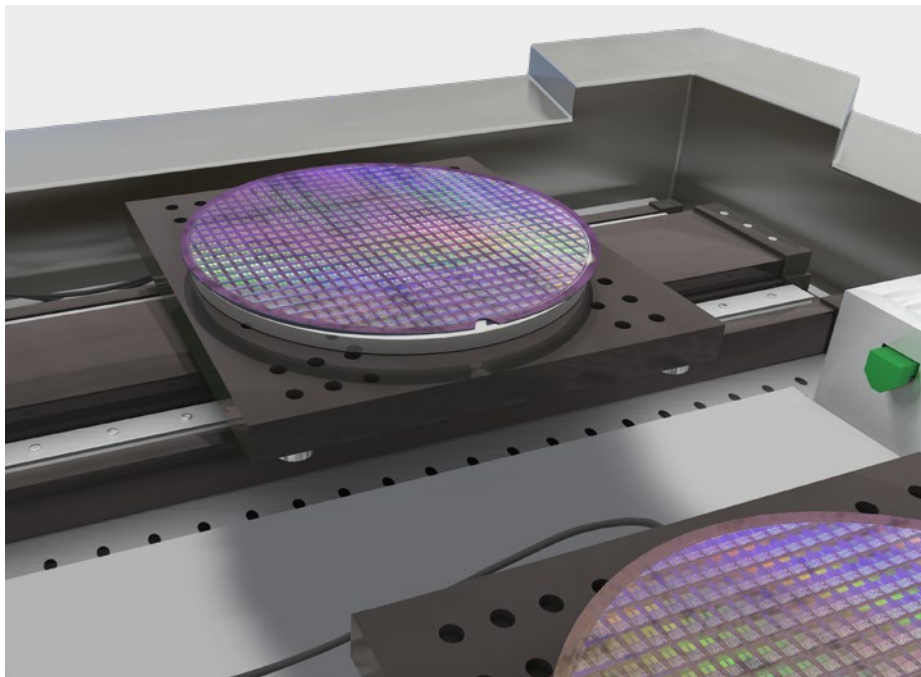

Positioning the wafer stage using capacitive sensors

Capacitive sensors are used for fine positioning in the wafer stage. Thanks to their triaxial design, the sensors are insensitive to electromagnetic fields and achieve a resolution in the nanometer range. They also achieve extremely high long-term stability.

Sensor: capaNCDT

Mirror tilt and beam stabilization

- Quick measurement of mirror tilt
- High angular resolution
- Bandwidth 1 kHz

Mirror tilt monitoring

Micro-Epsilon offers highly integrated actuator systems for challenging environmental conditions. One example is the fast steering mirror, which is equipped with optimized non-contact displacement sensors. This micromechatronic actuator system is used in lithography as well as in singulation to monitor the rapid tilting of mirrors as well as beam stabilization.

Specification FSM3000

Mirror diameter	20 mm
Overall diameter	26 mm
Range	$\pm 1.5^\circ$
Angular resolution	$2 \mu\text{rad rms}$
Bandwidth	1 kHz

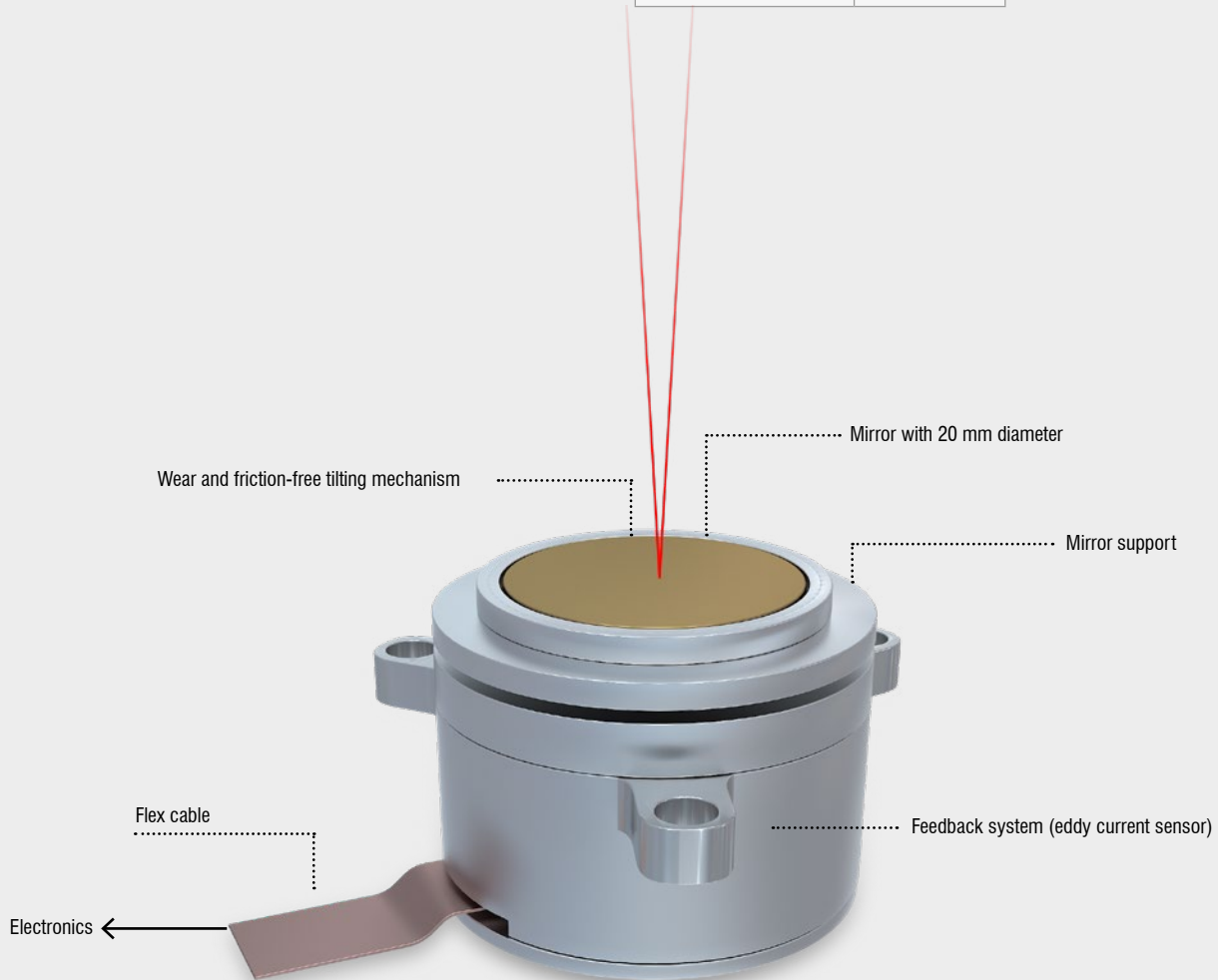

Inline quality control

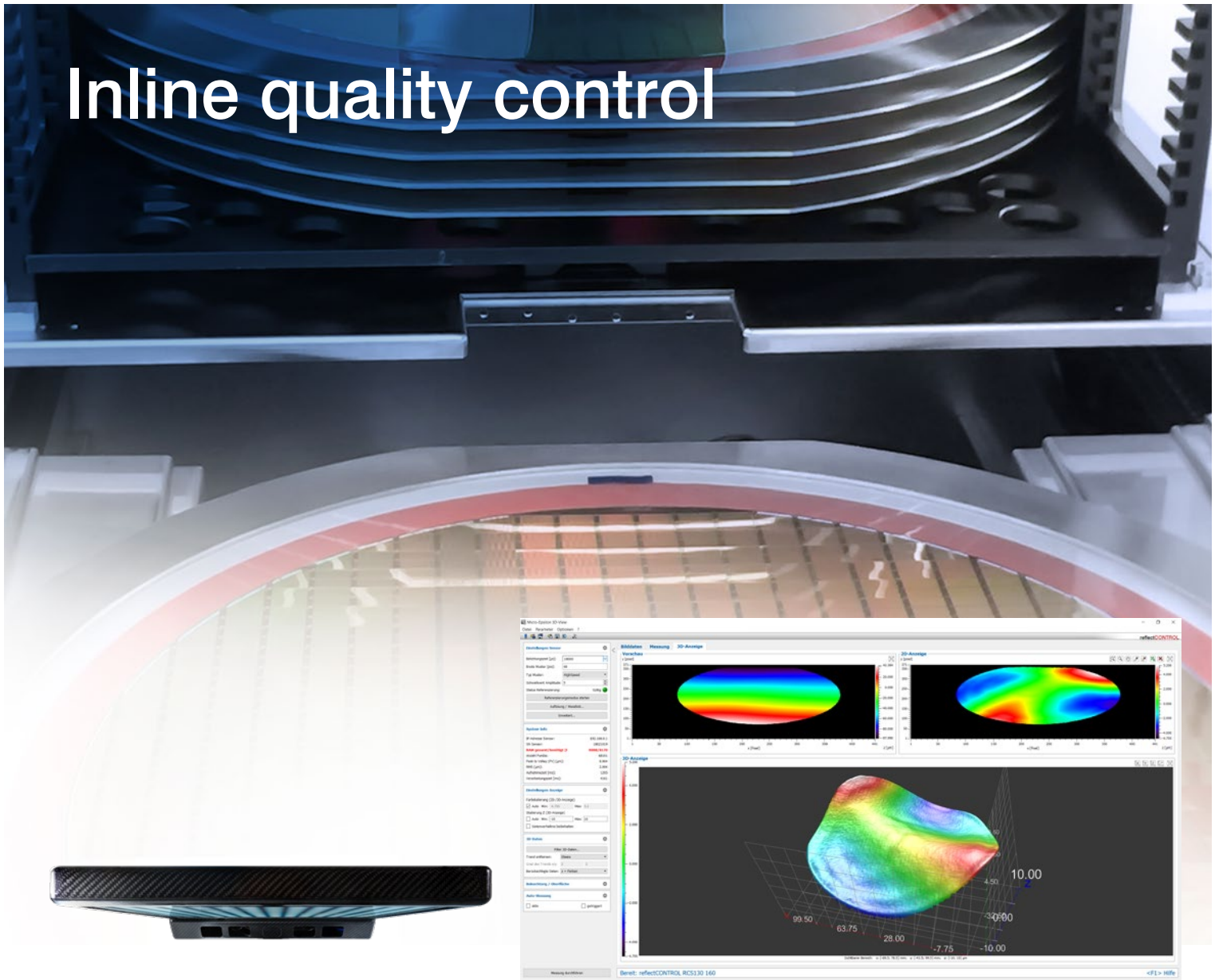

3D shape detection for wafers (Ø 150 mm)

Deflectometry systems are used to measure the flatness or planarity of wafers in a single image capture step. The sensor provides a 3D representation of the reflective surface, which can be used to determine the topology with micrometer precision.

Sensor: *reflectCONTROL* Sensor

Precise quality inspection of wafers

The inspection of wafers takes place over numerous process steps. White light interferometers and confocal chromatic sensors are preferred for in-line geometry inspection. They stand out from the competition thanks to a resolution in the subnanometer range, a small light spot and the possibility of integration in vacuum environments.

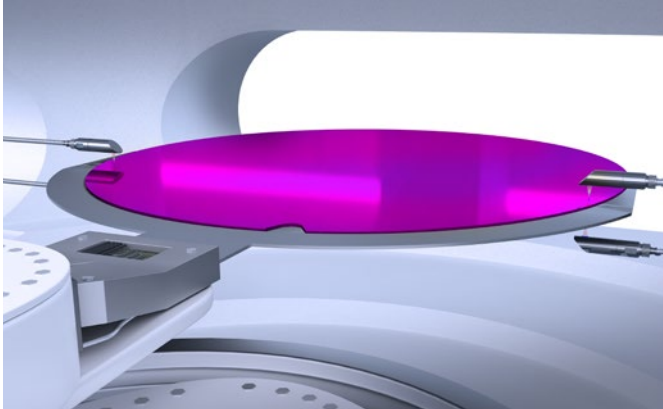

Confocal chromatic sensors measure the thickness deviation or wafer thickness from both sides.

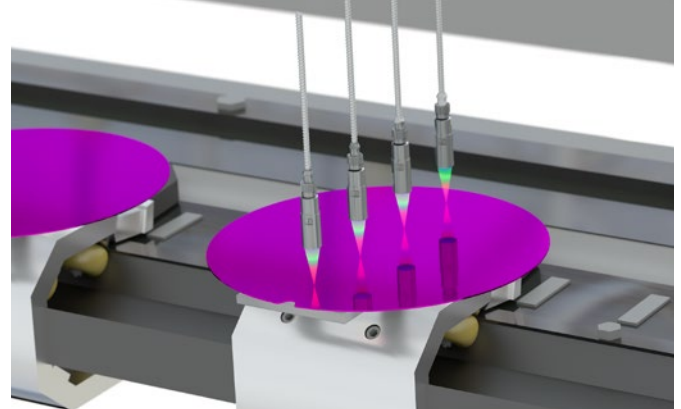

Confocal chromatic sensors scan the surface of wafers to detect deflection and warpage.

Further measurement and inspection tasks

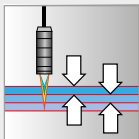

Measurement of transparent coatings

One-sided thickness measurement of single and multi-layer coatings

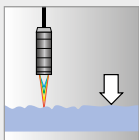

Checking for cracks and breaks

High-precision inspection of cracks and other defects on the wafer

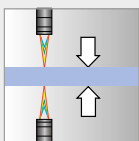

Wafer thickness measurement / TTV

Two-sided measurement of thickness deviation or wafer thickness

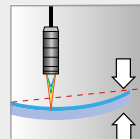

Bow and warp

Measurement of wafer deflection and warpage

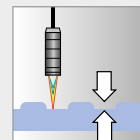

Detection and measurement of bumps on silicon wafers

High-resolution dimensional inspection of bumps

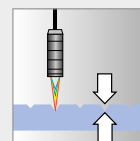

Detection and measurement of saw marks

Automatic detection and measurement of saw marks, predetermined breaking points and the slightest depressions on the wafer

Sensors and Systems from Micro-Epsilon



Sensors and systems for displacement, distance and position



Sensors and measurement devices for non-contact temperature measurement



Measuring and inspection systems for metal strips, plastics and rubber

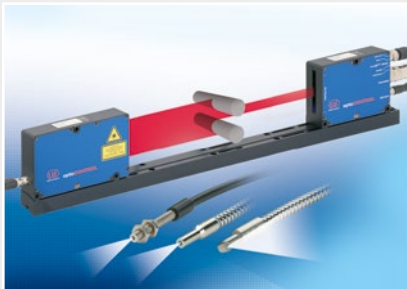

Optical micrometers and fiber optics, measuring and test amplifiers



Color recognition sensors, LED analyzers and inline color spectrometers



3D measurement technology for dimensional testing and surface inspection

More Precision

Whether it is for quality assurance, predictive maintenance, process and machine monitoring, automation or R&D – sensors from Micro-Epsilon make a vital contribution to the improvement of products and processes. High precision sensors and measuring systems solve measurement tasks in all core industries – from machine building to automated production lines and integrated OEM solutions.



www.micro-epsilon.com