



Operating Instructions
IF2035-EtherCAT



EtherCAT interface module

MICRO-EPSILON MESSTECHNIK
GmbH & Co. KG
Koenigbacher Str. 15

94496 Ortenburg / Germany

Tel: +49 (0) 8542 / 168-0
Fax: +49 (0) 8542 / 168-90
info@micro-epsilon.com
<https://www.micro-epsilon.com>

Contents

1	Safety.....	5
1.1	Symbols used.....	5
1.2	Warnings.....	5
1.3	Notes on product marking.....	5
1.3.1	CE marking.....	5
1.3.2	UKCA marking.....	5
1.4	Intended use.....	6
1.5	Proper Environment.....	6
2	Functional principle, technical data.....	7
2.1	Functional principle.....	7
2.2	Technical data.....	7
3	Delivery.....	8
3.1	Unpacking, included in delivery.....	8
3.2	Storage.....	8
4	Installation and assembly.....	9
4.1	Installation of the interface module.....	9
4.2	Electrical connections.....	9
4.2.1	Terminal strips.....	9
4.2.2	Supply voltage.....	10
4.2.3	Serielle Sensoranschlüsse.....	11
4.2.4	Cable termination at serial interface.....	12
4.3	Fieldbus cabling.....	12
5	Initial operation.....	14
5.1	Configuring the sensors.....	14
5.2	Baud rate and sensor interface.....	14
5.3	Data format.....	15
5.4	CoE object directory.....	15
5.4.1	Manufacturer-specific objects.....	15
5.4.1.1	Object 2000h: Select sensor.....	15
5.4.1.2	Object 2001h: Sensor addresses.....	15
5.4.1.3	Object 2010h: Device error log.....	15
5.4.1.4	Object 2020h: Baud rate.....	15
5.4.1.5	Object 2023h: Select serial interface.....	16
5.4.1.6	Object 2024h: Delete flash.....	16
5.4.1.7	Object 2025h: Delete flash for sensor settings.....	16
5.4.1.8	Object 2026h: Reset IF2035.....	16
5.4.1.9	Object 2027h: Enable HTT synchronization.....	16
5.4.1.10	Object 2210h: Device information.....	16
5.4.1.11	Object 2213h: Diagnosis block.....	17
5.4.1.12	Object 2220h: Sensor information.....	17
5.4.1.13	Object 2501h: Parameter information.....	18
5.4.1.14	Object 2510h: Float parameters.....	18
5.4.1.15	Object 2520h: Integer parameters.....	18
5.4.1.16	Object 2530h: Unsigned integer parameters.....	19
5.4.1.17	Object 2540h: String parameters.....	19
5.4.1.18	Object 2600h: RS422 command.....	19
5.4.2	Communication-specific standard objects.....	20
5.4.2.1	Overview.....	20
5.4.2.2	Object 1000h: Device type.....	20
5.4.2.3	Object 1018h: Device identification.....	20
5.4.2.4	Object 1C32h: Synchronization manager output parameters.....	20
5.4.2.5	Object 1C33h: Synchronization manager input parameters.....	20
5.4.2.6	Object 3005h: Controller identification.....	21
5.5	TxPDO mapping.....	21
5.6	Oversampling.....	22
5.7	Operational modes.....	22
5.7.1	Free run.....	22
5.7.2	Distributed clocks SYNC0 synchronization.....	23



5.7.3	SM2/SM3 Synchronization.....	23
6	Sensor values, data format, conversion.....	24
6.1	General.....	24
6.2	ACC5703.....	24
6.3	ACS7000.....	25
6.4	DT6120.....	26
6.5	IFC2421, IFC2422, IFC2465, IFC2465.....	27
6.6	ILD1220/1320/1420.....	28
6.7	ILD1750.....	28
6.8	ILD1900.....	29
6.9	ILD2300.....	29
6.10	ILR2250.....	30
6.11	IMS5400-TH, IMS5400-DS, IMS5600-DS.....	31
6.12	INC5701.....	32
6.13	DTD, MSC7xxx.....	33
6.14	MFA-7 / 14 / 21 / 28.....	33
6.15	ODC2520.....	34
6.16	ODC2700.....	34
7	Disclaimer.....	35
8	Service, repair.....	36
9	Decommissioning, Disposal.....	37
	Index.....	38

1 Safety



1.1 Symbols used

System operation assumes knowledge of the operating instructions.

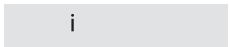
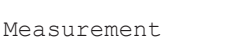
The following symbols are used in these operating instructions:

	Indicates a hazardous situation which, if not avoided, may result in minor or moderate injury.
	Indicates a situation that may result in property damage if not avoided.
	Indicates a user action.
	Indicates a tip for users.
	Indicates hardware or a software button/menu.

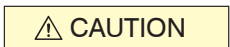
1.2 Warnings

	<p>Connect the power supply according to the regulations for electrical equipment.</p> <ul style="list-style-type: none"> • Risk of injury • Damage or destruction of interface module
	<p>The supply voltage must not exceed the specified limits.</p> <ul style="list-style-type: none"> • Damage or destruction of interface module • Avoid shocks and impacts to the interface module. • Damage or destruction of interface module

1.3 Notes on product marking

1.3.1 CE marking

The following apply to the product:

- Directive 2014/30/EU ("EMC")
- Directive 2011/65/EU ("RoHS")

Products which carry the CE marking satisfy the requirements of the EU Directives cited and the relevant applicable harmonized European standards (EN).

The product is designed for use in industrial and laboratory environments.

The EU Declaration of Conformity and the technical documentation are available to the responsible authorities according to the EU Directives.

1.3.2 UKCA marking

The following apply to the product:

- SI 2016 No. 1091 ("EMC")
- SI 2012 No. 3032 („RoHS")

Products which carry the UKCA marking satisfy the requirements of the directives cited and the relevant applicable harmonized standards.

The product is designed for use in industrial and laboratory environments.

The UKCA Declaration of Conformity and the technical documentation are available to the responsible authorities according to the UKCA Directives.

1.4 Intended use

The interface module is designed for use in an industrial environment.

It is used to convert the internal Micro-Epsilon sensor protocol (RS485, RS422) to EtherCAT.

The interface module must only be operated within the limits specified in the technical data.

The interface module must be used in such a way that no persons are endangered or machines and other material goods are damaged in the event of malfunction or total failure.

Take additional precautions for safety and damage prevention in case of safety-related applications.

1.5 Proper Environment

Protection class:	IP20
Temperature range:	
- Operation:	0 ... +50 °C
- Storage:	-20 ... +70 °C
Humidity:	5 ... 95% (non-condensing)
Ambient pressure:	Atmospheric pressure



EtherCAT® is registered trademark and patented technology, licensed by Beckhoff Automation GmbH, Germany.

2 Functional principle, technical data

2.1 Functional principle

The IF2035/PNET EtherCAT interface module is used to convert the internal Micro-Epsilon sensor protocol (RS485 or RS422) to EtherCAT.

Features:

- LED status display
- EtherCAT interface
- DIN rail housing

2.2 Technical data

Model	IF2035-EtherCAT	IF2035-PROFINET	IF2035-EIP
Speed ^[1]	0.25 ms	1 ms, 0.5 ms (IRT)	1 ms
Supply voltage	9 ... 36 VDC		
Power consumption	approx. 1.25 W with 24 VDC (without sensor)		
Digital interface	RS422, RS485 (with Micro-Epsilon specific data protocol), baud rate 9600 baud ... 4 MBaud, EtherCAT	RS422, RS485 (with Micro-Epsilon specific data protocol), baud rate 9600 baud ... 4 MBaud, PROFINET	RS422, RS485 (with Micro-Epsilon specific data protocol), baud rate 9600 baud ... 4 MBaud, EtherNet/IP
Digital output	Digital output synchronization (TTL, HTL) for RS422 sensors		
Connection	2 x RJ45 for fieldbus, 4 screw terminals for sensor connection and power supply		
Mounting	DIN rail 35 mm		
Temperature range	Storage	-20 ... 70°C	
	Operation	0 ... 50 °C	
Humidity	5 % RH ... 95 % RH (non condensing)		
Shock (DIN EN 60068-2-27)	5 g, 6 ms, 1000 shocks, 3 axes in 2 directions each		
Vibration (DIN EN 60068-2-6)	2 g, sinusoidal excitation with 50 ... 2000 Hz, 10 cycles, 3 axes		
Protection class (DIN EN 60529)	IP20		
Compatibility	RS485	inertialSENSOR: ACC5703, INC5701; capaNCDT 6120; induSENSOR MSC7401, MSC7602, MSC7802, DTD	
	RS422	optoNCDT 1220, 1320, 1420, 1900, 2300; confocalDT 242x, 246x; interferoMETER IMS5400-TH, IMS5400-DS, IMS5600-DS; colorCONTROL ACS7000, MFAX; optoCONTROL 2520; 2700 optoNCDT ILR2250	
Control and indicator elements	4 status LEDs (System, Status, RUN, ERR)	4 status LEDs (System, Status, COM0, COM1)	4 status-LEDs (System, Status, NS, MS)
Special features ^[2]	EtherCAT compliant 2.3.0.0 / Software integration in PLC: ESI file	Certification: PNIO V2.43 / Software integration in PLC: GSDML file	Certification: CT-19.1 / Software integration in PLC: EDS file
Weight	approx. 120 g		

[1] corresponds to the minimum cycle time

[2] available for download on Micro-Epsilon website

3 Delivery

3.1 Unpacking, included in delivery

- 1 IF2035-EtherCAT interface module
- 1 setup guide

- ▶ Carefully remove the components of the interface module from the packaging and ensure that the goods are forwarded in such a way that no damage can occur.
- ▶ Check the delivery for completeness and shipping damage immediately after unpacking.
- ▶ If there is damage or parts are missing, immediately contact the manufacturer or supplier.

3.2 Storage

Temperature range:	-20 ... +70 °C
Humidity:	5 ... 95% (non-condensing)

4 Installation and assembly

4.1 Installation of the interface module

i Ensure careful handling during installation and operation.

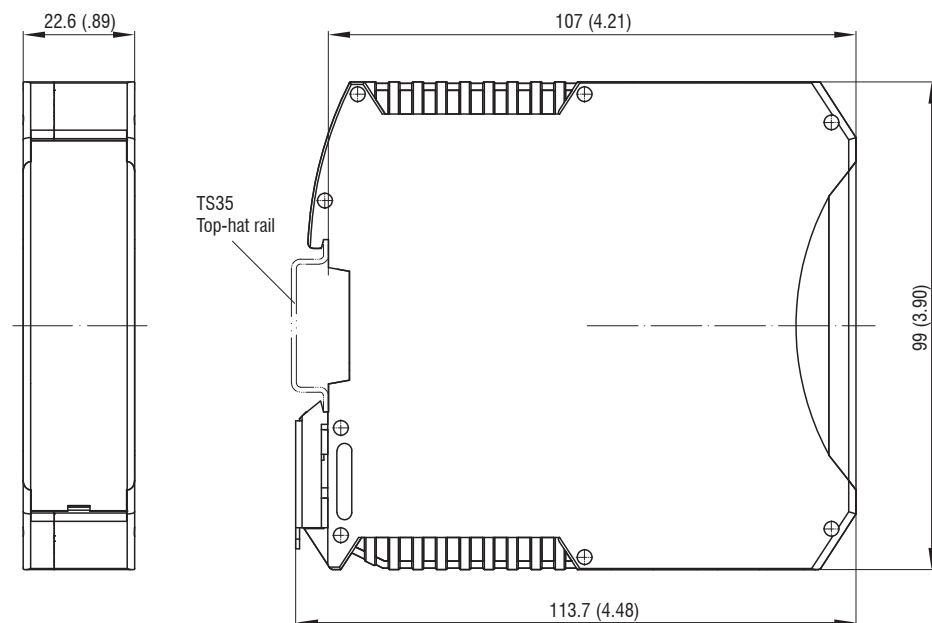

Fig. 4.1: IF2035-EIP dimensional drawing, dimensions in mm

4.2 Electrical connections

4.2.1 Terminal strips

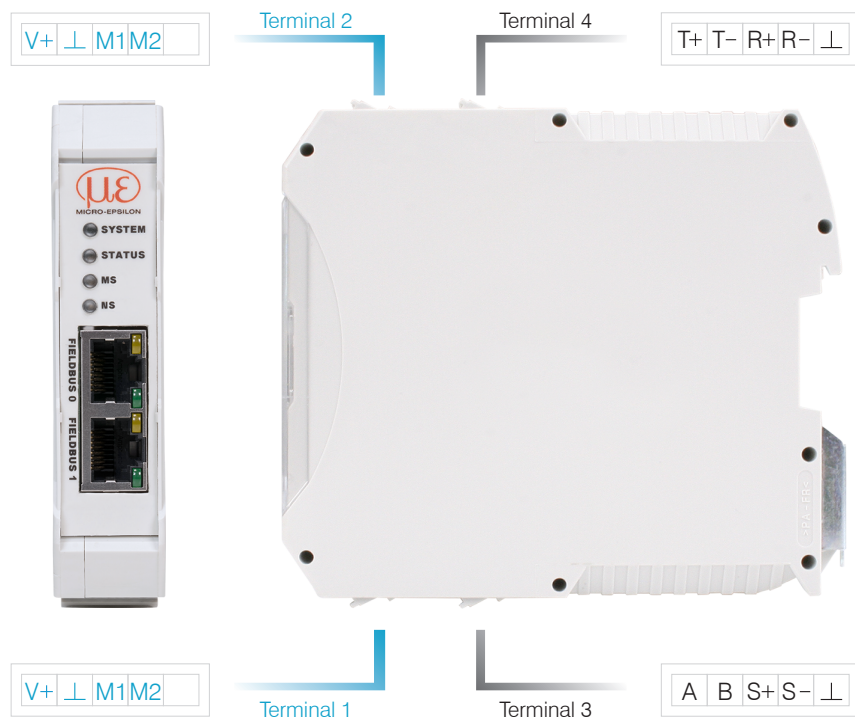

Fig. 4.2: Terminals interface module

Terminals 1 and 2	
V_+	Supply voltage
\perp	Ground for supply voltage ^[3]
M1, M2	Multifunction input 1/2 sensor
The connections of terminal 1 and 2 are daisy-chained	

Terminal 3	
A	RS485 A
B	RS485 B
S+	Synchronization output +
S-	Synchronization output -
\perp	Ground ^[4] e.g., for RS485 shield connection

Terminal 4	
T+	RS422 Tx+
T -	RS422 Tx-
R +	RS422 Rx+
R -	RS422 Rx-
\perp	Ground ^[4] e.g., for RS422 shield connection

4.2.2 Supply voltage

The supply voltage is daisy-chained from the supply port (terminal 1) to the sensor port (terminal 2), i.e., the supply voltage must match that of the sensor. Positive voltage must be between 9 V and 36 V.

- ▶ Connect the inputs V_+ and \perp to terminal 1 with a voltage supply. Maximum cable length 3 m.

The voltage supply must match that of the connected sensor, because the voltage is internally daisy-chained.

Micro-Epsilon recommends using the optionally available power supply unit PS2020, input 100 - 240 VAC, output 24 VDC/2.5 A, see Appendix.

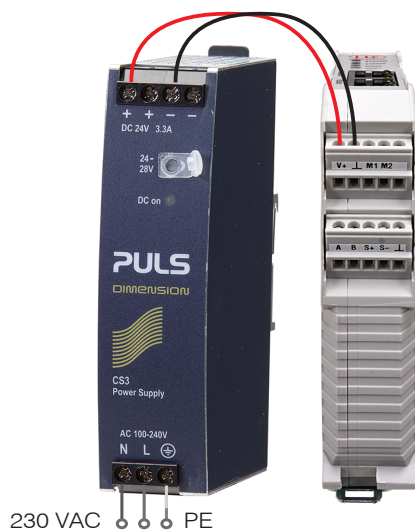

Fig. 4.3: Interface module with optional PS2020 power supply

[3] If the distance between IF2035-EtherCAT and the sensor/controller is long, a separate supply for the sensor/controller may be advisable.

[4] Internally connected to supply ground.

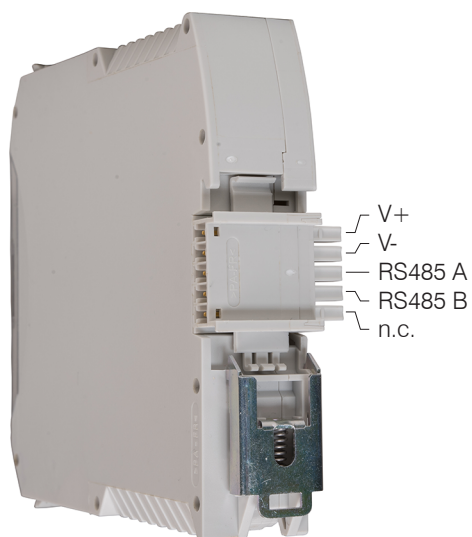

Fig. 4.4: Optional supply voltage wiring at rear of terminal

- i If the distance between IF2035-EtherCAT and the connected sensor/controller is long, Micro-Epsilon recommends that a separate supply be used for the sensor/controller.

4.2.3 Serielle Sensoranschlüsse

Sensor/Controller	Cable	RS485	RS422	Cable	Sensor/Controller
				CAB-M9-5P-St-ge; xm-PVC-RS422	ACS7000
ACC5703	PCx/8-M12			SC2471-x/RS422/OE	IFC242x, IFC246x
DT6120	SCAC3/6			Direct or PCF1420-x/I/U	ILD1x20
DTD	PC5/5-IWT			PC1700-x/OE	ILD1750
INC5701	PCx/8-M12			PC1900-x/OE	ILD1900
MSC7x0x	PC7400-6/4 Connector kid			PC2300-x/OE	ILD2300
				PC2250-x	ILR2250
				PC/SC2520-x	ODC2520
				PCSC2700-x	ODC2700
				SC2471-x/RS422/OE	IMS5400-TH, IMS5x00-DS
				CAB-M12-8P-St-ge; xm-PUR; open	MFA-x

Fig. 4.5: Anschlussbeispiele für das IF2035

Die Kabellänge zwischen IF2035-EtherCAT und Sensor/Controller beträgt maximal 10 m. Bei den Sensoren ACC5703 und INC5701 ist wegen des Kabels PCx/8-M12 eine Sensorversorgung ausschließlich über das IF2035-EtherCAT möglich.



Fig. 4.6: Anschluss einer MSC7602 mit MSC7602-Steckersatz

IF2035/EtherCAT	Sensor/Controller
RS422	
T+	R+
T-	R-
R+	T+
R-	T-
⊥	Kabelschirm
RS485	
A	A
B	B
⊥	Kabelschirm

Fig. 4.1: Verdrahtungsvorschrift für Verbindungen mit RS485 oder RS422

4.2.4 Cable termination at serial interface

i Ensure correct cable termination for an RS485 bus or RS422 bus.

Micro-Epsilon recommends a 120 ohm terminating resistor between the signal lines at both the bus start and end. IF2035 works as a master for both interfaces; internally, a 120 ohm terminating resistor has already been permanently incorporated. The IF2035 should be at the bus start.

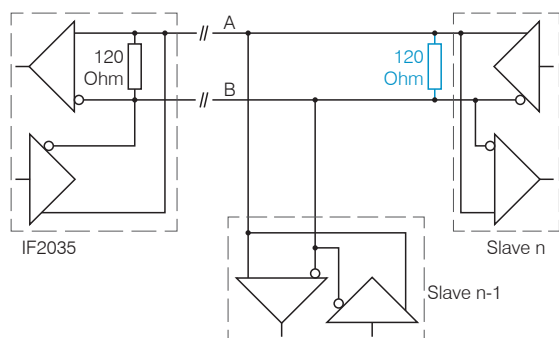

Fig. 4.7: Cable termination RS485, n = max. 16 slaves

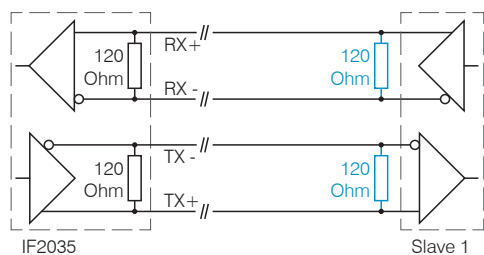

Fig. 4.8: Cable termination RS422

4.3 Fieldbus cabling

During cabling, channel 0 of the scanner is connected to a port of adapter 1 (slave device). The second port of the adapter 1 is connected to the port of the next adapter, etc. One port of the last adapter and channel 1 of the master device (scanner) remain unused.

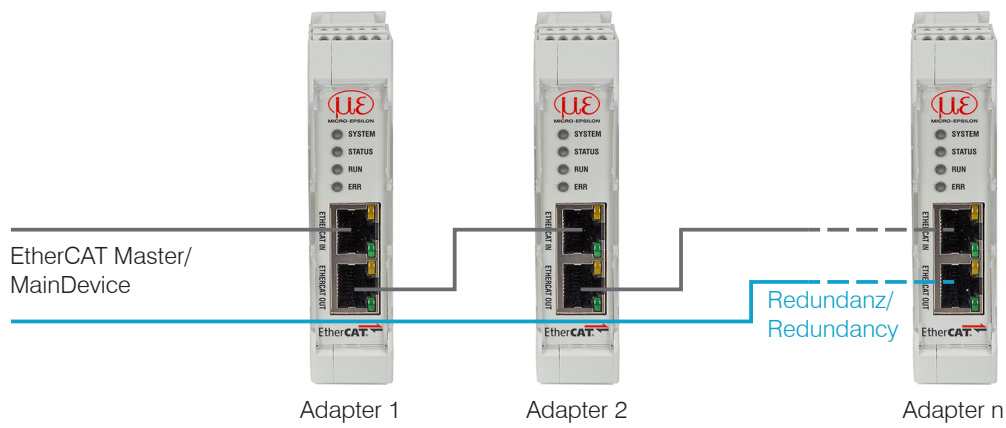

Fig. 4.9: Wiring in the EtherCAT Network

Optional: The IF2035 can participate in a device level ring as a ring node and thereby reduce the threat of failures through redundant cabling.

5 Initial operation

5.1 Configuring the sensors

The sensor used must be correctly configured to work with the IF2035-EtherCAT. Micro-Epsilon recommends that the sensor's base configuration be set by using its web interface. The configuration can later also be adjusted via fieldbus. Please refer to the operating instructions of the corresponding sensor for detailed information on configuring the sensor.

5.2 Baud rate and sensor interface

IF2035-EtherCAT must be set for the interface used and the sensor's baud rate.

Sensor/controller	Baud rate [baud]	Bus address	RS485	RS422
ACC5703	230400	126	•	
ACS7000	230400			•
DT6120	230400	126	•	
DTD	256000	^[5]	•	
IFC242x/246x	115200			•
ILD1x20	921600			•
ILD17x0	921600			•
ILD19x0	921600			•
ILD23x0	921600 ^[6]			•
ILR2250	115200			•
IMS5x00	115200			•
INC5701	230400	126	•	
MFA-7/14/21/28	115200			•
MSC7401	256000	^[5]	•	
MSC7602	256000	^[7]	•	
MSC7802	256000	^[5]	•	
ODC2520	115200			•
ODC2700	921600			•

Fig. 5.1: Baud rate (factory setting) of the sensors or controllers to be connected

The baud rate is defined in object 0x2020 and the sensor interface in object 0x2023, see chapter 5.4.

[5] The address is set via software, see controller operating instructions.

[6] When delivered, ILD23x0 is set to 691.2 kBaud. Increase the baud rate to 921.6 kBaud in the sensor.

[7] The address is set via DIP switch or software, see controller operating instructions.

5.3 Data format

All configuration parameters and data are transmitted in little-endian format.

Sensors/controllers with RS422:

The cyclical data is decoded, i.e. a 4th byte is added to the 3 bytes and then transmitted. The sensor signals selected for transfer and their sequence are available on the sensor's web interface.

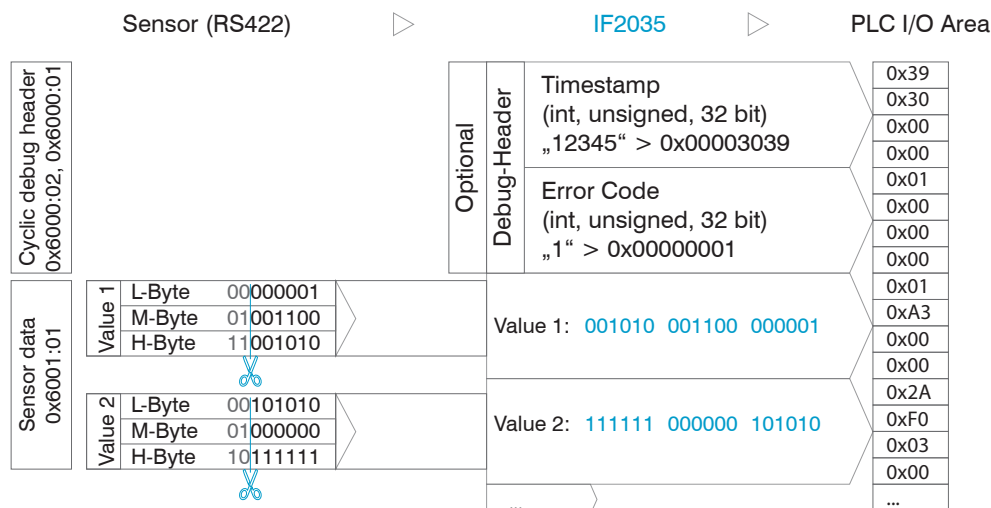

Fig. 5.1: Interpretation of RS422 sensor data in IF2035

Sensors/controllers with RS485:

The cyclical data are transmitted via the fieldbus without change, i.e., as a binary block as described and supplied by the sensor. Please refer to the sensor's operating instructions for the data block structure.

5.4 CoE object directory

5.4.1 Manufacturer-specific objects

5.4.1.1 Object 2000h: Select sensor

Index	Data type		Name	RS485	RS422	Description
0x2000	Uint8	RW	Select sensor	● ^[8]	○	Address of currently selected sensor

5.4.1.2 Object 2001h: Sensor addresses

Index	Data type		Name	RS485	RS422	Description
0x2001	U int8[32]	R	Sensor addresses	●	○	Shows address list of available sensors

5.4.1.3 Object 2010h: Device error log

Index	Data type		Name	RS485	RS422	Description
0x2010	Uint32[64]	R	Device error log	●	●	Reads out the last 32 error codes with time stamp

5.4.1.4 Object 2020h: Baud rate

Index	Data type		Name	RS485	RS422	Description
0x2020	Uint32	RW	Baud rate	●	●	Baud rate of the connected sensor

[8] ● Object is used for sensors with RS485 or RS422. ○ Object cannot be used for sensors with RS485 or RS422.

5.4.1.5 Object 2023h: Select serial interface

Index	Data type		Name	RS485	RS422	Description
0x2023	Uint8	RW	Sensor interface	•	•	0: RS485, 1: Reserved, 2: ASCII + RS422

5.4.1.6 Object 2024h: Delete flash

Index	Data type		Name	RS485	RS422	Description
0x2024	Uint8	RW	Reset device config	• ^[8]	•	One byte deletes settings from the flash, the settings are included in RAM until restart.

5.4.1.7 Object 2025h: Delete flash for sensor settings

Index	Data type		Name	RS485	RS422	Description
0x2025	Uint8	RW	Reset sensor config	•	○	One byte deletes the settings from the flash, the settings are included in RAM until restart.

5.4.1.8 Object 2026h: Reset IF2035

Index	Data type		Name	RS485	RS422	Description
0x2026	Uint8	RW	Reset device	•	•	One byte performs reset

5.4.1.9 Object 2027h: Enable HTT synchronization

Index	Data type		Name	RS485	RS422	Description
0x2027	Uint8	RW	Enable and disable HTTL sync	•	•	0: Deactivate HTTL synchronization 1: Activate HTTL synchronization

5.4.1.10 Object 2210h: Device information

Index	Data type		Name	RS485	RS422	Description
0x2210			Device info	•	○	Read out the block of the current sensor

Sub-indices

0	Uint8	R	Number of objects			
1	Uint8	R	Block version			Block version
2	Uint8	R	Endianness			Endian
3	Uint16	R	Software version			Software version
4	Int32	R	Article number			Article number
5	Int32	R	Option			Option
6	Int32	R	Batch number			Batch
7	Int32	R	Serial number			Serial number
8	Uint8	R	Change index			Change index
9	Uint8	R	Calibration day			Day of calibration
10	Uint8	R	Calibration month			Month of calibration
11	Uint8	R	Calibration year			Year of calibration
12	Uint16	R	Calibration software version			Version of calibration software
13	Uint16	R	Test software version			
14	Uint8	R	Test hour			
15	Uint8	R	Test day			

[8] • Object is used for sensors with RS485 or RS422. ○ Object cannot be used for sensors with RS485 or RS422.

16	UInt8	R	Test month			
17	UInt8	R	Test year			
18	Int32	R	Article number circuit board			
19	Int32	R	Serial number circuit board			
20	Int8[32]	R	Name			
21	UInt8	R	Sensor/channel count			
22	UInt8	R	Protocol block count			
23	UInt8[164]	R	Protocol blocks			

5.4.1.11 Object 2213h: Diagnosis block

Index	Data type	Name	RS485	RS422	Description
0x2213		Diagnostic block	● ^[8]	○	Query RS485 diagnosis block (if available)

Sub-indices

0	UInt8	R	Number of objects			
1	UInt8	RW	Page index to read			Specifying an index lets you scroll through existing pages
2	UInt8	R	Number of pages			
3	UInt8	R	Diagnosis type			
4	UInt8[235]	R	String page			Diagnostic message

5.4.1.12 Object 2220h: Sensor information

Index	Data type	Name	RS485	RS422	Description
0x2220		Sensor block	●	○	Request sensor information

Sub-indices

0	UInt8	R	Number of objects			
1	UInt8	RW	Block index offset			The offset lets you scroll through existing sensor blocks [0 ... 0x1F]
2	UInt8	RW	Page index to read			Specifying an index lets you scroll through existing pages
3	UInt8	R	Number of pages			Max. number of pages
4	Int8	R	Measurement unit			Signal unit
5	Int32	R	Article number			Article number
6	Int32	R	Option			Option
7	Int32	R	Batch			Batch
8	Int32	R	Serial number			Serial number
9	Float	R	Nominal measuring range			Nominal measuring range
10	Float	R	Nominal offset			Nominal offset
11	Float	R	Current measuring range			Actual measuring range
12	Float	R	Current offset			Actual offset
13	UInt8[32]	R	Target material			Target material
14	UInt8[32]	R	Sensor or channel name			Sensor or channel name
15	UInt8	R	Extension length			Length of block extension
16	UInt8[138]		Extension			

[8] ● Object is used for sensors with RS485 or RS422. ○ Object cannot be used for sensors with RS485 or RS422.

5.4.1.13 Object 2501h: Parameter information

Index	Data type	Name	RS485	RS422	Description
0x2501		Parameter Info	● ^[8]	○	Query configuration parameters, e.g., sensor exposure time, request via sub-index 1, configure interface with objects 0x2510 through 0x2540

Sub-indices

Index	Data type	Access	Name	RS485	RS422	Description
0	UInt8	R	Number of objects			
1	UInt16	RW	Parameter ID			Please refer to the sensor documentation for available parameter IDs and their types
2	UInt8[14]	R	Name			
3	UInt8[8]	R	Unit			
4	UInt8[8]	R	Type			

5.4.1.14 Object 2510h: Float parameters

Index	Data type	Name	RS485	RS422	Description
0x2510		Float parameter	●	○	Read or write float parameters

Sub-indices

Index	Data type	Access	Name	RS485	RS422	Description
0	UInt8	R	Number of objects			
1	UInt16	RW	Parameter ID			Please refer to the sensor documentation for available parameter IDs and their types
2	UInt8	RW	Reserved			
3	Float	RW	Value			Value
4	UInt8[14]	R	Name			Name
5	UInt8[8]	R	Unit			Unit as a string
6	Float	R	Min			
7	Float	R	Max			

5.4.1.15 Object 2520h: Integer parameters

Index	Data type	Name	RS485	RS422	Description
0x2520		Int parameter	●	○	Read or write integer parameter

Sub-indices

Index	Data type	Access	Name	RS485	RS422	Description
0	UInt8	R	Number of objects			
1	UInt16	RW	Parameter ID			Please refer to the sensor documentation for available parameter IDs and their types
2	UInt8	RW	Reserved			
3	Int32	RW	Value			Value
4	UInt8[14]	R	Name			Name
5	UInt8[8]	R	Unit			Unit as a string
6	Int32	R	Min			
7	Int32	R	Max			

[8] ● Object is used for sensors with RS485 or RS422. ○ Object cannot be used for sensors with RS485 or RS422.

5.4.1.16 Object 2530h: Unsigned integer parameters

Index	Data type	Name	RS485	RS422	Description
0x2530		Int parameter	● ^[8]	○	Read or write integer parameters

Sub-indices

Index	Data type	Access	Name	RS485	RS422	Description
0	UInt8	R	Number of objects			
1	UInt16	RW	Parameter ID			Information on available parameter IDs and their type can be found in the sensor documentation.
2	UInt8	RW	Reserved			
3	UInt32	RW	Value			Value
4	UInt8[14]	R	Name			Name
5	UInt8[8]	R	Unit			Unit as a string
6	UInt32	R	Min			
7	UInt32	R	Max			

5.4.1.17 Object 2540h: String parameters

Index	Data type	Name	RS485	RS422	Description
0x2540		String parameter	●	○	Read or write string parameter

Sub-indices

Index	Data type	Access	Name	RS485	RS422	Description
0	UInt8	R	Number of objects			
1	UInt16	RW	Parameter ID			Please refer to the sensor documentation for available parameter IDs and their types
2	UInt8	RW	Reserved			
3	UInt8[246]	RW	Value			Value
4	UInt8[14]	R	Name			Name

5.4.1.18 Object 2600h: RS422 command

Index	Data type	Name	RS485	RS422	Description
0x2600		RS422 ASCII access	○	●	ACII command via RS422

Sub-indices

Index	Data type	Access	Name	RS485	RS422	Description
0	UInt8	R	Number of objects			
1	UInt8[128]	RW	Send Cmd			Buffer for a 128-character ASCII command, termination with '\n' or 0x0A Send commands as a binary block, e.g. "MEASRATE 1" corresponds to 4D 45 41 53 52 41 54 45 20 31 0A.
2	UInt8[896]	R	Cmd answer			Answer from sensor without shortening, e.g., Line feed; if buffer overflows, e.g., PRINT ALL, answer is truncated

[8] ● Object is used for sensors with RS485 or RS422. ○ Object cannot be used for sensors with RS485 or RS422.

5.4.2 Communication-specific standard objects

5.4.2.1 Overview

Index	Name	Description, value
1000	Device type	Device type, IF2035
1008	Device name	IF2035-EtherCAT
1009	Hardware version	1
100A	Software version	2
1018	Identity object	Device identification, IF2035
10F8	Timestamp	0x11ccceafae (1223208663790)
1A00	Cyclic Debug Header, Sensor Data xyz Byte	TxPDO mapping, (Mappable objects - process data)
...		
1A90		
1C00	Sync manager type	Synch. manager type
1C12	RxPDO assign	
1C13	TxPDO assign	TxPDO assignment
1C32	Output SyncManager Parameters	Synchronization and Timing Settings
1C33	Input SyncManager Parameters	
3005	Controller info	Includes information from standard objects, see below

5.4.2.2 Object 1000h: Device type

1000	VAR	Device type	0x00000000	UInt32	ro
------	-----	-------------	------------	--------	----

Provides information about the used device profile and the device type.

5.4.2.3 Object 1018h: Device identification

1018	RECORD	Identity			
------	--------	----------	--	--	--

Sub-indices

0	VAR	Number of entries	4	UInt8	ro
1	VAR	Vendor ID	0x0000065E (1630)	UInt32	ro
2	VAR	Product code	0x634FA400 (1666163712)	UInt32	ro
3	VAR	Revision	0x00000002 (2)	UInt32	ro
4	VAR	Serial number	0x0000039B (923)	UInt32	ro

5.4.2.4 Object 1C32h: Synchronization manager output parameters

See description of input parameters, see Chap. 5.4.2.5.

5.4.2.5 Object 1C33h: Synchronization manager input parameters

1C33	RECORD	SM Input Parameter			
------	--------	--------------------	--	--	--

Sub-indices

0	VAR	Number of entries	32	UInt8	ro
1	VAR	Synchronization type		UInt32	rw
2	VAR	Cycle time		UInt32	rw
4	VAR	Synchronization types supported		UInt16	ro
5	VAR	Minimum cycle time		UInt32	ro

6	VAR	Calc and copy time		UInt32	ro
9	VAR	Delay time		UInt32	ro
0C	VAR	Cycle time too small counter		UInt16	ro
20	VAR	Sync error		Bool	ro

- Synchronization type: currently specified synchronization type
- Cycle Time: currently specified cycle time in ns or SYNC0 time with Distributed Clock
 - Freerun: IF2035 local cycle time
 - Sync0 synchronization: the Sync0 cycle time set by the master
- Supported synchronization types:
 - Freerun
 - SM2 / SM3
 - Sync0 Synchronization
- 0x1C32:04 Supported synchronization types 0x0807
- 0x1C33:04 Supported synchronization types 0x0007
- 0x1C32:05 Minimum cycle time: 250000 ns
- 0x1C33:05 Minimum cycle time: 250000 ns
- 0x1C32:06 Calc and copy time: 0 (no RxPDO)
- 0x1C33:06 Calc and copy time: 10000 ns
- 0x1C32:09 Delay time: 0
- 0x1C33:09 Delay time: 25000 ns

5.4.2.6 Object 3005h: Controller identification

3005	RECORD	Controller info			
------	--------	-----------------	--	--	--

Sub-indices

0	VAR	Number of entries	8	UInt8	ro
1	VAR	Name	IF2035-EtherCAT	String	ro
5	VAR	Serial number	923	UInt32	ro
6	VAR	Option number	0	UInt32	ro
4	VAR	Article number	2211036	String	ro

5.5 TxPDO mapping

Only the objects 0x1Ax0 are valid for the RS485 interface. The objects 0x1Ax1, 0x1Ax2 and 0x1Ax3 cannot be selected.

Oversampling is possible for the RS422 interface. The objects 0x1Ax0, 0x1Ax1, 0x1Ax2 and 0x1Ax3 can be selected

The TxPDO must be selected so that sufficient memory is reserved for the data to be transmitted.

The output is a byte array, see chapter 5.3 (data format)

In TwinCAT, for example, link from the byte array to the corresponding variables or interpret the binary data.

0x1A00	Cyclic Debug Header TxPDOMap				
	0x6000:001 Timestamp				
	0x6000:002 Last error				

0x1A10	Sensor Data 16 Bytes TxPDOMap OV1				
	0x6001:001 Sensor Data[0]				

0x1A11	Sensor Data 16 Bytes TxPDOMap OV2				
	0x6001:001 Sensor Data[0]	0x6001:002 Sensor Data[1]			

0x1A12	Sensor Data 16 Bytes TxPDOMap OV4			
	0x6001:001 Sensor Data[0]	0x6001:002 Sensor Data[1]	0x6001:003 Sensor Data[2]	0x6001:004 Sensor Data[3]
0x1A13	Sensor Data 16 Bytes TxPDOMap OV8			
	0x6001:001 Sensor Data[0]	0x6001:002 Sensor Data[1]	0x6001:003 Sensor Data[2]	0x6001:004 Sensor Data[3]
	0x6001:005 Sensor Data[4]	0x6001:006 Sensor Data[5]	0x6001:007 Sensor Data[6]	0x6001:008 Sensor Data[7]
...	...			
0x1A20	Sensor Data 32 Bytes TxPDOMap OV1			
	0x6002:001 Sensor Data[0]			
...	...			
0x1A90	Sensor Data 880 Bytes TxPDOMap OV1			
	0x6009:001 Sensor Data[0]			
...	...			

5.6 Oversampling

In operation without oversampling, the last accumulated measured value data set is transferred to the EtherCAT master with each fieldbus cycle. Therefore, for long fieldbus cycle periods many data records with measured values are not available. Configurable oversampling ensures that all (or selected) measured value data records are gathered and transmitted together to the master during the next fieldbus cycle.

The oversampling factor specifies how many samples per bus cycle are transmitted. For example, an oversampling factor of 2 means that 2 samples are transferred per bus cycle.

Currently the IF2035 supports oversampling of 1, 2, 4 and 8.

With TxPDO Mapping, the base index of the PDO mapping objects is included with the oversampling factor 1. Use the following list to determine the index for selecting a different oversampling factor:

- Base index + 1: Oversampling factor 2
- Base index + 2: Oversampling factor 4
- Base index + 3: Oversampling factor 8

Multiple sensor data PDOs of different sizes or with different oversampling factors cannot be selected.

Example:

The fieldbus/EtherCAT master operates at a cycle time of 1 ms because the higher-level PLC works with a cycle time of 1 ms. This means that the IF2035 provides an EtherCAT frame every 1 ms. If the connected sensor is operated with a measurement frequency of 4 kHz, an oversampling of 4 must be set.

⊕ 1A10:0	Sensor Data 16 Byte TxPDOMap	RO	> 1 <
⊕ 1A11:0	OV2 Sensor Data 16 Byte TxPDOMap	RO	> 2 <
⊖ 1A12:0	OV4 Sensor Data 16 Byte TxPDOMap	RO	> 4 <
⋮ 1A12:01	SubIndex 001	RO	0x6001:01, 128
⋮ 1A12:02	SubIndex 002	RO	0x6001:02, 128
⋮ 1A12:03	SubIndex 003	RO	0x6001:03, 128
⋮ 1A12:04	SubIndex 004	RO	0x6001:04, 128
⊕ 1A13:0	OV8 Sensor Data 16 Byte TxPDOMap	RO	> 8 <

i The IF2035 is a gateway.

Oversampling is currently only supported for the RS422 sensor interface.

5.7 Operational modes

5.7.1 Free run

There is no synchronization between sensor and EtherCAT master. The PDOs are updated based on the internal cycle time of the IF2035. The cycle time is set using object 0x1C32/1C33:002. PDO frames may be lost or duplicated.

5.7.2 Distributed clocks SYNC0 synchronization

Sensor and EtherCAT master are synchronized via the Sync0 cycle time. The PDOs are updated based on the internal Sync0 cycle time, which replaces the internal cycle time. In this mode, an EtherCAT master can synchronize the measurement acquisition for the EtherCAT cycle time and the measurement acquisition of multiple controllers.

Note that although the measurements in the sensor are synchronized to the Sync0 cycle time, the transmission of the values to the EtherCAT master is again asynchronous with the bus cycle. Synchronous transmission of the values to the EtherCAT master is only given if oversampling and Sync0 cycle time are in the right relation to the bus cycle, [see Chap. 5.6](#).

The ESI file contains predefined SYNC0 cycle times. However, you can set any cycle time between ≥ 250000 ns (measuring rate= 4 kHz), e.g. a cycle time of 10000000 ns (measuring rate=100 Hz). The cycle time should match the measuring rate set in the sensor and the selected oversampling factor.

5.7.3 SM2/SM3 Synchronization

The sensor supplies current data to the EtherCAT master with every SM2 or SM3 event. Please note that the data of the PDOs are updated with the internal measuring rate independent of the bus cycle. This can cause PDO frames to be lost or duplicated.

6 Sensor values, data format, conversion

6.1 General

The sensors or controllers do not solely output distance values. The overview below describes the conversion during output of distance values. Please refer to the corresponding operating instructions for detailed information on conversion when additional values are output.

6.2 ACC5703

Baud rate	230400 b/s	RS485 half-duplex	Max. sampling rate 1 kHz: measurements with variable number factory-set scaled to ± 2 g, little-endian
Bus address	126		

Byte data	Meaning	Data format
Data[0]	Status byte (contains error flag, normally 0x00)	8 bits
Data[1] ... Data[4]	Measurement counter [bit 00:31]	Uint 32 bit
Data[5]	Number of measured values in this package = $3 \cdot x$ with $x [1 \dots 19]$	8 bits
Data[6]	Padding byte	8 bits
Data[7]	Padding byte	8 bits
Data[8]	Measured value 1 x-axis [bit 0:7]	Float 32 bit
Data[9]	Measured value 1 x-axis [bit 8:15]	
Data[10]	Measured value 1 x-axis [bit 16:23]	
Data[11]	Measured value 1 x-axis [bit 24:31]	
...	...	
Data[n] $n=8+(4 \cdot \text{Data}[5]/3)$	Measured value 1 y-axis [bit 0:7]	Float 32 bit
Data[n+1]	Measured value 1 y-axis [bit 8:15]	
Data[n+2]	Measured value 1 y-axis [bit 16:23]	
Data[n+3]	Measured value 1 y-axis [bit 24:31]	
...	...	
Data[n+m] $m=4 \cdot \text{Data}[5]/3$	Measured value 1 z-axis [bit 0:7]	Float 32 bit
Data[n+m+1]	Measured value 1 z-axis [bit 8:15]	
Data[n+m+2]	Measured value 1 z-axis [bit 16:23]	
Data[n+m+3]	Measured value 1 z-axis [bit 24:31]	

Please refer to the operating instructions of the acceleration sensor for more information. The current version is available at:

<https://www.micro-epsilon.com/download-file/man--inertialSENSOR-ACC5703--en.pdf>

6.3 ACS7000

RS422 Measuring rate 250 Hz factory-set, all color values and color distances. Up to 32 output values can be transmitted at the same time.

Baud rate 115200 b/s

The ACS7000 supplies 3 bytes per value at the output. These are coded by the IF2035-EtherCAT into 4 bytes, see Chap. 5.3.

Group	Name	Index	Raw		Scaled			
			Min	Max	Min	Max	Formula	Unit
Status	Frame rate	1	2500	250000	20.00	2000.00	$10^6/(x*12.5*2^4)*1000$	Hz
	Shutter	2	2500	250000	20.00	2000.00	$x*12.5*2^4/10^9$	μ s
	TempDetector	3	-1024	1023	-256.00	255.75	$x/4$	°C
	TempLightSrc	4	-1024	1023	-256.00	255.75	$x/4$	°C
LightSensor	Red	5	0	65535	0.00	100.00	$x/65536*100$	%
	Green	6	0	65535	0.00	100.00	$x/65536*100$	%
	Blue	7	0	65535	0.00	100.00	$x/65536*100$	%
	Brightness	8	0	65535	0.00	100.00	$x/65536*100$	%
Status	Counter	9	0	262143	0	262143	x	-
	Timestamp	10	0	262143	0.00	67.11	$x*256/100000$	s
Color	XYZ	11 - 13	0	131072	0.00	256.00	$x/512$	-
	RGB	14 - 16	0	131072	0.00	256.00	$x/512$	-
	LAB	17 - 19	-131072	131071	-256.00	256.00	$x/512$	-
	LUV	20 - 22	-131072	131071	-256.00	256.00	$x/512$	-
	LCH (L/C)	23 - 24	-131072	131071	-256.00	256.00	$x/512$	-
	LCH (H)	25	0	131071	0.00	256.00	$x/512$	°
	LAB99	26 - 28	-131072	131071	-256.00	256.00	$x/512$	-
	LCH99 (L/C)	29 - 30	-131072	131071	-256.00	256.00	$x/512$	-
LCH99 (H)	31	0	184320	0.00	360	$x/512$	°	
Status	Error	32	0	262143	0	262143	x	-
Distance	1_1/2/3	33 - 35	NA	-				
	...	36 - 77						
	16_1/2/3	78 - 80						
	Min_1/2/3	81 - 83	-131072	131071	-256.00	256.00	$x/512$	-
	DetectedID	84	0	16	0	16	-	-
	MinDistID	85	0	16	0	16	-	-

Fig. 6.1: Overview of output data via RS422

Please refer to the operating instructions for the color measuring system colorCONTROL ACS7000 for more information, especially about possible output values. The current version is available at:

<https://www.micro-epsilon.com/download-file/man--colorCONTROL-ACS7000--en.pdf>

6.4 DT6120

Baud rate	230400 b/s	RS485 half-duplex	Measurements factory-set scaled to sensor measuring range, little-endian
Bus address	126		

Measuring data consist of a counter, the packet length m and the measurements. The packet length m determines how many measurements are transmitted. The packet length m is the number of measurements that have been queried by the electronic system since the last time measuring data were queried, but is limited to the most recent 20 measurements. The first measurement in the data [] package is the oldest value queried, the last one is the most recently queried value.

Byte data	Meaning	Data format
Data[0]	Counter [7:0]	Unsigned short
Data[1]	Counter [15:8]	
Data[2]	Packet length m [7:0]	Unsigned char
Data[3]	Filler byte [7:0]	Unsigned char
Data[4]	Measured value 1 [7:0]	Signed integer
Data[5]	Measured value 1 [15:8]	
Data[6]	Measured value 1 [23:16]	
Data[7]	Measured value 1 [31:24]	
	...	
Data[...]	Measured value m [7:0]	Signed integer
Data[...]	Measured value m [15:8]	
Data[...]	Measured value m [23:16]	
Data[...]	Measured value m [31:24]	

Fig. 6.2: Encoding of DT6120 measured values in the transmission protocol

Scaling of measurements

By default, 24-bit measurements are transmitted.

The following equivalences therefore apply:

0x0 = 0% of the sensor measuring range

0xF00000 = 100% of the sensor measuring range

If the sensor is outside the measuring range, accordingly larger measurement values are output.

Please refer to the operating instructions for the capacitive displacement measuring system for more information. The current version is available at:

<https://www.micro-epsilon.com/download-file/man--capaNCDT-6110-6120IP--en.pdf>

6.5 IFC2421, IFC2422, IFC2465, IFC2465

RS422	The data are configured or selected via ASCII commands or via the web interface.
Baud rate	115200 baud factory-set

The controller delivers 3 bytes of data per distance value at the output. These bytes are coded by the IF2035 into 4 bytes. The associated measurement values are displayed in the web diagram; i.e. the output must be redirected to the RS422 interface.

The selection of output data from all internally determined values and from the calculated values from the computing modules is done separately for the interfaces. These data are output in a rigidly defined order. The web interface displays this order.

Variables	Formula
d = Digital output value	$x = \frac{(d_{\text{OUT}} - 98232) * MR}{65536}$
d_{OUT}	
x = Distance / thickness in mm	
MR = Measuring range in mm	

Fig. 6.3: Conversion of the linearized measurement values into millimeters

For more information, especially on the possible output values, please refer to the operating instructions for the confocal chromatic distance and thickness measuring system. The current version is available at:

<https://www.micro-epsilon.com/download-file/man--confocalDT-2421-2422-2465-2466--en.pdf>

6.6 ILD1220/1320/1420

RS422 The data are configured or selected via ASCII commands or via the web interface.
Baud rate 921600 b/s factory-set

- i The sensor can continue to supply measured values to the RS422 output even while the sensor is communicating.

The digital measurements are output at the sensor as unsigned digital values (raw values). The sensors supply 3 bytes per value at the output. These bytes are coded by the IF2035 into 4 bytes, see Chap. 5.3.

The linearized measurement values can be converted in millimeters using the subsequent formula:

Value	Variables	Value range	Formula
Distance	x = digital value	[0; <643] SMR reserve [643; 64877] Measuring range [>64877; 65520] EMR reserve	$d \text{ [mm]} = \frac{1}{100} \left(\frac{102}{65520} x - 1 \right) * MR \text{ [mm]}$
	MR = measuring range [mm]	{10/25/50/100/200/500}	
	d = distance [mm]	[-0.01MB; 1.01MB]	

Fig. 6.4: Calculation of distance value from the digital value, ILD1220/1320/1420

Please refer to the operating instructions for the laser-optical displacement sensors optoNCDT 1220/1320/1420 for more information, especially about possible output values. The current version is available at:

<https://www.micro-epsilon.com/download-file/man--optoNCDT-1220--en.pdf>

<https://www.micro-epsilon.com/download-file/man--optoNCDT-1320--en.pdf>

<https://www.micro-epsilon.com/download-file/man--optoNCDT-1420--en.pdf>

6.7 ILD1750

RS422 The data are configured or selected via ASCII commands or via the web interface.
Baud rate 921600 b/s factory-set

- i The sensor can continue to supply measured values to the RS422 output even while the sensor is communicating.

The digital measurements are output at the sensor as unsigned digital values (raw values). The sensors supply 3 bytes per value at the output. These bytes are coded by the IF2035 into 4 bytes, see Chap. 5.3.

The linearized measurement values can be converted in millimeters using the subsequent formula:

Value	Variables	Value range	Formula
Distance	x = digital value	[0; 230604] Measuring range	$d \text{ [mm]} = \frac{x - 98232}{65536} * MR \text{ [mm]}$
	MR = measuring range [mm]	{2/10/20/50/100/200/500/750}	
	d = distance [mm]	without mastering [-0.01MR; 1.01MR] with mastering [-2MR; 2MR]	

Fig. 6.5: Calculation of distance value from the digital value, ILD1750

Please refer to the operating instructions for the laser-optical displacement sensors optoNCDT 1750 for more information, especially about possible output values. The current version is available at:

<https://www.micro-epsilon.com/download-file/man--optoNCDT-1750--en.pdf>

6.8 ILD1900

RS422 The data are configured or selected via ASCII commands or via the web interface.
Baud rate 921600 b/s factory-set

i The sensor can continue to supply measured values to the RS422 output even while the sensor is communicating.

The digital measurements are output at the sensor as unsigned digital values (raw values). The sensors supply 3 bytes per value at the output. These bytes are coded by the IF2035 into 4 bytes, see Chap. 5.3.

The linearized measurement values can be converted in millimeters using the subsequent formula:

Value	Variables	Value range	Formula
Distance	x = digital value	[0; 230604] Measuring range	$d \text{ [mm]} = \frac{x - 98232}{65536} * MR \text{ [mm]}$
	MR = measuring range [mm]	{2/6/10/25/50/100/200/500}	
	d = distance [mm]	without mastering [-0.01MR; 1.01MR] with mastering [-2MR; 2MR]	

Fig. 6.6: Calculation of distance value from the digital value, ILD1900

Please refer to the operating instructions for the laser-optical displacement sensors optoNCDT 1900 for more information, especially about possible output values. The current version is available at:

<https://www.micro-epsilon.com/download-file/man--optoNCDT-1900--en.pdf>

6.9 ILD2300

RS422 The data are configured or selected via ASCII commands or via the web interface.
Baud rate 921600 b/s factory-set^[9]

i The sensor can continue to supply measured values to the RS422 output even while the sensor is communicating.

The digital measurements are output at the sensor as unsigned digital values (raw values). 16 Bit per value are transmitted. The sensors supply 3 bytes per value at the output. These bytes are coded by the IF2035 into 4 bytes, see Chap. 5.3.

The linearized measurement values can be converted in millimeters using the subsequent formula:

Value	Variables	Value range	Formula
Distance	x = digital value	[0; <643] SMR reserve [643; 64877] Measuring range [>64877; 65520] EMR reserve	$d \text{ [mm]} = \frac{1}{100} \left(\frac{102}{65520} x - 1 \right) * MR \text{ [mm]}$
	MR = measuring range [mm]	{2/5/10/20/40/50/100/200/300}	
	d = distance [mm]	[-0.01MB; 1.01MB]	

Fig. 6.7: Calculation of distance value from the digital value, ILD2300

Please refer to the operating instructions for the laser-optical displacement sensors optoNCDT 2300 for more information, especially about possible output values. The current version is available at:

<https://www.micro-epsilon.com/download-file/man--optoNCDT-2300--en.pdf>

[9] When delivered, ILD2300 is set to 691.2 kBaud. Increase the baud rate to 921.6 kBaud in the sensor.

6.10 ILR2250

RS422	The data are configured or selected via ASCII commands or via the sensorTOOL program.	
Baud rate	115200 baud factory-set	
Minimum Cycle Time	50 ms	
Data format	Each data frame consists of the timestamp in ms and the distance in 1/10 mm, followed by a footer byte. Each value is transmitted in 4 bytes; the lower 7 bits are used for the data. The 4*7 bits are combined into a 28 bit value. The sensor outputs the data in big-endian format.	

The linearized measured values can be converted into millimeters according to the following formula:

Value	Variables	Formula
Distance	x = Digital output value d = distance [mm]	$d \text{ [mm]} = x / 10$

Fig. 6.8: Calculation of distance value from the digital value, ILR2250

For further information, in particular the data format, please refer to the operating instructions for the optoNCDT ILR2250 laser distance sensor. The current version is available at:

<https://www.micro-epsilon.com/download-file/man--optoNCDT-ILR-22xx--en.pdf>

6.11 IMS5400-TH, IMS5400-DS, IMS5600-DS

RS422	The data are configured or selected via ASCII commands or via the web interface.
Baud rate	115200 baud factory-set

The associated measurement values are displayed in the web diagram; i.e. the output must be redirected to the RS422 interface.

The selection of output data from all internally determined values and from the calculated values from the computing modules is done separately for the interfaces. These data are output in a rigidly defined order. The web interface displays this order.

A data value (measurement value) consists of at least 2 and at most 5 bytes. A data package consists of one or several data values and a footer, which concludes the data packet.

Data type, value range, scaling and unit vary depending on the data value. Details can be found in the interferoMETER IMS5x00 operating instructions.

For more information, please refer to the interferometer operating instructions, especially about possible output values. The current version is available at:

<https://www.micro-epsilon.com/download-file/man--interferoMETER-5x00--en.pdf>

6.12 INC5701

Baud rate 230400 b/s RS485 half-duplex Max. sampling rate 250 Hz, factory-set INC5701D, little-endian
 Bus address 126

Byte data	Meaning	Data format
Data[0]	Status byte (contains error flag, normally 0x00)	8 bits
Data[1]	Long term values counter [bit 0:7]	Uint 32 bit
Data[2]	Long term values counter [bit 8:15]	
Data[3]	Long term values counter [bit 16:23]	
Data[4]	Long term values counter [bit 24:31]	
Data[5]	Number of measured values in this package = 3*x with x [1 ... 19]	8 bits
Data[6]	Padding byte	8 bits
Data[7]	Padding byte	8 bits
Data[8]	Measured value 1 [bit 0:7]	Float 32 bit
Data[9]	Measured value 1 [bit 8:15]	
Data[10]	Measured value 1 [bit 16:23]	
Data[11]	Measured value 1 [bit 24:31]	
Data[12]	Measured value 2 [bit 0:7]	Float 32 bit
Data[13]	Measured value 2 [bit 8:15]	
Data[14]	Measured value 2 [bit 16:23]	
Data[15]	Measured value 2 [bit 24:31]	

Fig. 6.9: Encoding of measured values in the transmission protocol, INC5701S

Byte data	Meaning	Data format
Data[0]	Status byte (contains error flag, normally 0x00)	8 bits
Data[1] ... Data[4]	Measurement counter [bit 00:31]	Uint 32 bit
Data[5]	Number of measured values in this package	8 bits
Data[6], Data[7]	Padding byte	8 bits
Data[8]	Measured value 1 LP ^[10] [bit 0:7]	Float 32 bit
Data[9]	Measured value 1 LP [bit 8:15]	
Data[10]	Measured value 1 LP [bit 16:23]	
Data[11]	Measured value 1 LP [bit 24:31]	
Data[12]	Measured value 2 LP [bit 0:7]	
Data[13]	Measured value 2 LP [bit 8:15]	
Data[14]	Measured value 2 LP [bit 16:23]	
Data[15]	Measured value 2 LP [bit 24:31]	
...	...	
Data[n] n=8+(4*Data [5])	Measured value 1 SF ^[11] [bit 0:7]	Float 32 bit
Data[n+1]	Measured value 1 SF [bit 8:15]	
Data[n+2]	Measured value 1 SF [bit 16:23]	
Data[n+3]	Measured value 1 SF [bit 24:31]	
Data[n+4]	Measured value 2 SF [bit 0:7]	
Data[n+5]	Measured value 2 SF [bit 8:15]	
...	...	

Fig. 6.10: Encoding of INC5701 measured values in the transmission protocol, INC5701D

[10] LP = Low-pass filter

[11] SF = SensorFUSION Filter

Please refer to the operating instructions for the inclination sensor for more information. The current version is available at:

<https://www.micro-epsilon.com/download-file/man--inertialSENSOR-INC5701--en.pdf>

The measurement data consist of a status byte, a measurement value counter, the number of measurement values, and the measurement values themselves. The measurement value counter continuously counts in ascending order with each sampled value. It represents the number of measured values buffered in the sensor since the last enquiry by the master and therefore represents the number of the measured values transmitted in this package (floats). The first measurement value in the Data[] packet is the oldest measurement value. A measured value is represented as 4-byte float data type in the unit angular degrees [°].

6.13 DTD, MSC7xxx

Baud rate	256000 Baud factory-set, [9600 ... 256000]	RS485 half-duplex	Measurements factory-set scaled to analog value, little-endian
Bus address	126 [2 ... 126]		

Sequence for a measurement value request:

Send	0x10	0x7E ^[12]	0x01 ^[13]	0x4C	0xCB ^[14]	0x16				
Receive	0x68	0x0B	0x0B	0x68	0x01 ^[13]	0x7E ^[12]	0x08			
	0xAE	0x47	0x61	0x3F	0x00	0x00	0x00	0x00		
	Unscaled value				Scaled value					
	0x1C ^[15]	0x16								
Result	Description		Format		Example					
	Unscaled value		Bytes 8 - 11: 4 bytes, float, little-endian		0x3F6147AE (float) = 0.88 V					
	Scaled value		Bytes 12 - 15: 4 bytes, float, little-endian		If this value is 0, the controller was not set up. Otherwise the digital counterpart of the analog output will be sent according to the setting you have done in the controller before.					
Maximum speed for data transmission (1x send + 1x receive): ~3 ms @ 256,000 Baud										

Fig. 6.11: Encoding of MSC7xxx measured values in the transmission protocol

Please refer to the operating instructions for the inductive displacement measuring system for more information. The current version is available at:

<https://www.micro-epsilon.com/download-file/man--induSENSOR-MSC7xxx--en.pdf>

6.14 MFA-7 / 14 / 21 / 28

RS422	Binary format for measured values, commands as ASCII character string or via the sensorTOOL.
Baud rate	115200 b/s factory-set

The controller supplies 3 bytes per color temperature value at the output.

This raw value must then be converted into the desired color model.

For further information, especially on the possible output values, factors and offsets for a scaled color in the desired color model, please refer to the operating instructions for the color measuring system. The current version is available at:

<https://www.micro-epsilon.com/download-file/man--colorCONTROL-MFA-7--en.pdf>

[12] DA: 126

[13] SA: 1

[14] CH: Checksum Send: Byte 2 - 4

[15] CH: Checksum Receive: Byte 5 - 15

6.15 ODC2520

RS422	The data are configured or selected via ASCII commands or via the web interface.
Baud rate	115200 baud factory-set

Ex factory, the controller outputs the measurements in the Edge light-dark measuring program to the web diagram, i.e., output must be redirected to the RS422 interface.

The sensors supply 3 bytes per value at the output. These bytes are coded by the IF2035 into 4 bytes, 15.

The linearized measurement values can be converted in μm using the subsequent formula:

Value	Variables	Formula
Edge position	x = Digital output value; $x \geq 262072$ are error values d = Measurement value (edge position, difference, center axis) in μm	$d [\mu\text{m}] = x - 131000$

Fig. 6.12: Calculation of edge position from the digital value, ODC2500

Please refer to the operating instructions for the laser micrometer optoCONTROL 2520 for more information. The current version is available at:

<https://www.micro-epsilon.com/download-file/man--optoCONTROL-2520--en.pdf>

6.16 ODC2700

RS422	The data are configured or selected via ASCII commands or via the web interface.
Baud rate	921600 baud factory-set

The preset "strip edge" is factory-set in the controller. The associated measurement values are displayed in the web diagram; i.e. the output must be redirected to the RS422 interface.

The selection of output data from all internally determined values and from the calculated values from the computing modules is done separately for the interfaces. These data are output in a rigidly defined order. The web interface displays this order.

A data value (measurement value) consists of at least 2 and at most 5 bytes. A data package consists of one or several data values and a footer, which concludes the data packet.

Data type, value range, scaling and unit vary depending on the data value. Details can be found in the optoCONTROL 2700 operating instructions.

For more information, please refer to the laser micrometer operating instructions, especially about possible output values. The current version is available at:

<https://www.micro-epsilon.com/download-file/man--optoCONTROL-2700--en.pdf>

7 Disclaimer

All components of the device have been checked and tested for functionality in the factory. However, should any defects occur despite careful quality control, these shall be reported immediately to Micro-Epsilon or to your distributor / retailer.

Micro-Epsilon undertakes no liability whatsoever for damage, loss or costs caused by or related in any way to the product, in particular consequential damage, e.g., due to

- non-observance of these instructions/this manual,
- improper use or improper handling (in particular due to improper installation, commissioning, operation and maintenance) of the product,
- repairs or modifications by third parties,
- the use of force or other handling by unqualified persons.

This limitation of liability also applies to defects resulting from normal wear and tear (e.g., to wearing parts) and in the event of non-compliance with the specified maintenance intervals (if applicable).

Micro-Epsilon is exclusively responsible for repairs. It is not permitted to make unauthorized structural and / or technical modifications or alterations to the product. In the interest of further development, Micro-Epsilon reserves the right to modify the design.

In addition, the General Terms of Business of Micro-Epsilon shall apply, which can be accessed under

Legal details | Micro-Epsilon <https://www.micro-epsilon.com/legal-details/>.

8 Service, repair

If the interface module is defective

- Please send us the affected parts for repair or exchange.
- If the cause of a fault cannot be clearly identified, please send the entire system including cables to:

MICRO-EPSILON MESSTECHNIK
GmbH & Co. KG
Koenigbacher Str. 15
94496 Ortenburg / Germany

Tel: +49 (0) 8542 / 168-0
Fax: +49 (0) 8542 / 168-90
info@micro-epsilon.com
www.micro-epsilon.com/contact/worldwide/
<https://www.micro-epsilon.com>

9 Decommissioning, Disposal

In order to avoid the release of environmentally harmful substances and to ensure the reuse of valuable raw materials, we draw your attention to the following regulations and obligations:

- Remove all cables from the sensor and/or controller.
- Dispose of the sensor and/or the controller, its components and accessories, as well as the packaging materials in compliance with the applicable country-specific waste treatment and disposal regulations of the region of use.
- You are obliged to comply with all relevant national laws and regulations.

For Germany / the EU, the following (disposal) instructions apply in particular:

- Waste equipment marked with a crossed garbage can must not be disposed of with normal industrial waste (e.g. residual waste can or the yellow recycling bin) and must be disposed of separately. This avoids hazards to the environment due to incorrect disposal and ensures proper recycling of the old appliances.



- A list of national laws and contacts in the EU member states can be found at https://ec.europa.eu/environment/topics/waste-and-recycling/waste-electrical-and-electronic-equipment-weee_en. Here you can inform yourself about the respective national collection and return points.

- Old devices can also be returned for disposal to Micro-Epsilon at the address given in the legal details at <https://www.micro-epsilon.com/legal-details>.

- We would like to point out that you are responsible for deleting the measurement-specific and personal data on the old devices to be disposed of.

- Under the registration number WEEE-Reg.-Nr. DE28605721, we are registered at the foundation Elektro-Altgeräte Register, Nordostpark 72, 90411 Nuremberg, as a manufacturer of electrical and/or electronic equipment.



MICRO-EPSILON MESSTECHNIK GmbH & Co. KG
Koenigbacher Str. 15 94496 Ortenburg / Germany
Tel. +49 (0) 8542 / 168-0 Fax +49 (0) 8542 / 168-90
info@micro-epsilon.com <https://www.micro-epsilon.com>
Your local contact: www.micro-epsilon.com/contact/worldwide/

X9751462-A022124MSC
© MICRO-EPSILON MESSTECHNIK